



Air gripper—HFZ Series

Parallel style with guide track—ball bearing

Compendium of HFZ Series

Seven kinds of bore size and three kinds of type

Bore size: 6, 10, 16, 20, 25, 32, 40,
 HFZ: Double acting
 HFSZ: Single acting and normally closed
 HFTZ: Single acting and normally opened

Integrated design of linear guide rail

Integrated design of linear guide rail,
 high rigidity and high precision.

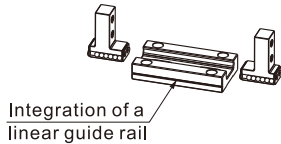

With positioning pin

A positioning pin is attached to the bottom
 of the linear guide rail, which can prevent
 the deviation of the positioning rail and body.

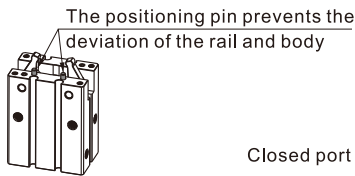

Four kinds of finger type

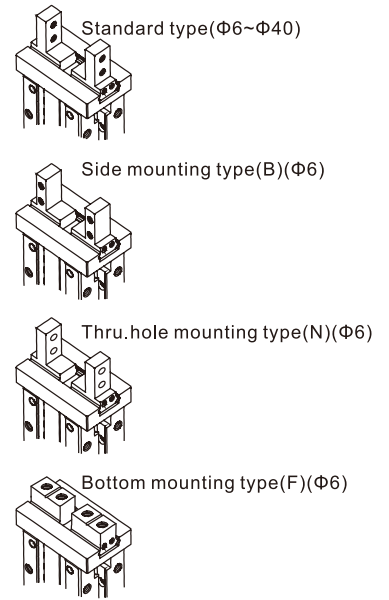

According to the actual using requirements of
 customers, the initial position of clamping jaw
 can be customized to meet the different needs
 under different working conditions.

Can be mounted from three directions

With mounting holes on the side and tail.

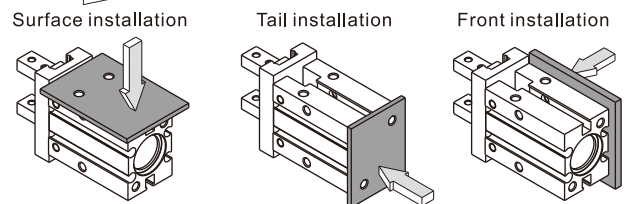

With squareness magnetic switch slots

The squareness magnetic switch slots convenient
 to install DMSG(S)\CMSG type inducting switch.

With roundness magnetic switch slots

The roundness magnetic switch slots convenient
 to install DMSH(S)\CMSH type inducting switch.

With positioning hole

The positioning hole can improve the precision and the
 consistency of
 repeated
 dismantling and
 positioning.

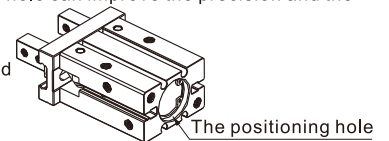

Bore size (mm)		6	10	16	20	25	32	40	
Acting type		Double acting			Single acting				
Fluid		Air (to be filtered by 40μm filter element)							
Operating pressure	Double acting	Φ6, Φ10	0.2~0.7MPa(28~100psi)(2.0~7.0bar)						
		Others	0.15~0.7MPa(22~100psi)(1.5~7.0bar)						
	Single acting	Φ6, Φ10	0.35~0.7MPa(50~100psi)(3.5~7.0bar)						
		Others	0.25~0.7MPa(36~100psi)(2.5~7.0bar)						
Temperature °C		-20~70							
Lubrication		Not required							
Repeatability mm		±0.01				±0.02			
Max. frequency		180(c.p.m)				60(c.p.m)			
Sensor switches		DMSH/CMSH		DMSG\CMSG, DMSH\CMSH					
Port size		M3×0.5			M5×0.8				

Note) Refer to P524 for detail of sensor switch.



Air gripper(parallel style——ball bearing)

HFZ Series



Symbol

HFZ: Double acting

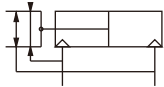

HFTZ: Single acting and normally opened

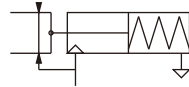

HFSZ: Single acting and normally closed

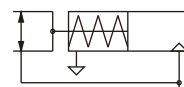

Gripping force and stroke

Acting type		Double acting(HFZ)						Single acting_NO (HFTZ)						Single acting_NC (HFSZ)								
Bore size		6	10	16	20	25	32	40	6	10	16	20	25	32	40	6	10	16	20	25	32	40
Gripping force per finger Effective value(N)	External	3.3	11	34	45	69	160	255	1.9	7	27	35	55	133	220	-	-	-	-	-	-	-
	Internal	6.1	17	45	68	102	195	320	-	-	-	-	-	-	-	3.7	13	38	59	87	163	270
Opening/Closing stroke(Both sides)(mm)		3	4	6	10	14	22	30	3	4	6	10	14	22	30	3	4	6	10	14	22	30
Weight (g)	F Type	24	-	-	-	-	-	-	25	-	-	-	-	-	-	25	-	-	-	-	-	-
	Others	25	56	124	236	428	729	1268	26	57	125	238	430	778	1365	26	57	125	238	430	778	1365

[Note] The gripping force in the above table is in the working pressure of 0.5MPa, and with a gripping point of L=20mm.

Add) Please refer to page 464 for the definition of "L".

Ordering code

HFZ 20 □

① ② ③

① Model	② Bore size	③ Finger type			
HFZ: Air finger(Double acting) HFSZ: Air finger (Single acting and normally closed) HFTZ: Air finger (Single acting and normally opened)	6 10 16 20 25 32 40	Blank: Standard 			
	6	B: Side mounting type 	N: Thru. hole mounting type 	F: Bottom mounting type 	HFZ series are all attached with magnet.

Inner structure and material of major parts

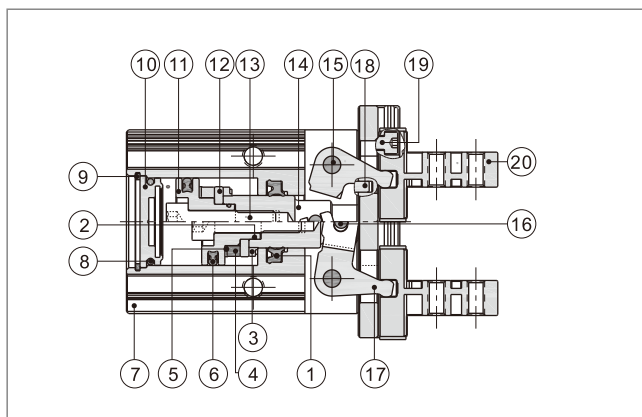

NO.	Item	Material
1	Rod packing	NBR
2	O-ring	NBR
3	Bumper	TPU
4	Magnet	Sintered metal(Neodymium-iron-boron)
5	Magnet washer	NBR
6	Piston seal	NBR
7	Body	Aluminum alloy
8	O-ring	NBR
9	C clip	Spring steel
10	Back cover	Aluminum alloy
11	Piston	Aluminum alloy/Stainless steel
12	Magnet fixed flake	Stainless steel
13	Screw	Carbon steel
14	Piston rod	Aluminum alloy/Stainless steel
15	Pin	Stainless steel
16	Pin	Stainless steel
17	Curved bar	Stainless steel
18	Pin	Stainless steel
19	Countersink screw	Carbon steel
20	Assembly of clamping jaw and guide rail	Stainless steel

Air gripper(parallel style——ball bearing)



HFZ Series

Dimensions

Standard

Φ6

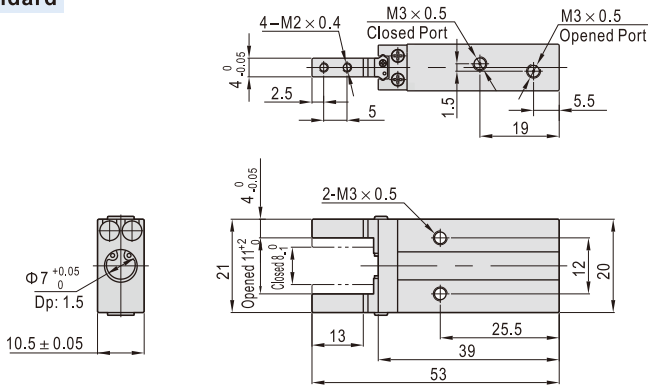

Φ10~Φ40

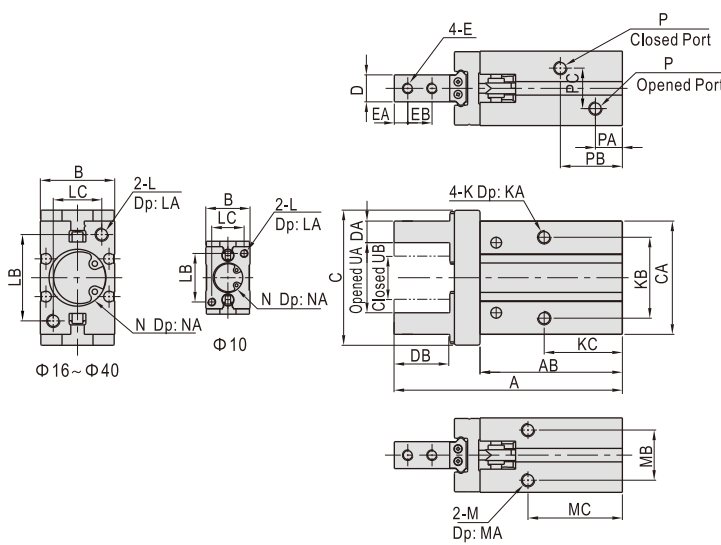

Model\Item	A	AB	B	C	CA	D	DA	DB	E	EA
HFZ10	57	37.5	16.5	30	23	5 ^{-0.05} ₀	4 ^{-0.05} ₀	12	M2.5×0.45	3
HFZ16	67.5	42.5	23.5	39	30.5	8 ^{-0.05} ₀	5 ^{-0.05} ₀	15	M3×0.5	4
HFZ20	85	53	27.5	53	42	10 ^{-0.05} ₀	8 ^{-0.05} ₀	20	M4×0.7	5
HFZ25	103	64	33.5	71	52	12 ^{-0.05} ₀	10 ^{-0.05} ₀	25	M5×0.8	6
HFZ32	113(122)	67(76)	40	106	60	15 ^{-0.05} ₀	12 ^{-0.05} ₀	29	M6×1.0	7
HFZ40	139(152)	83(96)	48	132	72	18 ^{-0.05} ₀	14 ^{-0.05} ₀	36	M8×1.25	9

Model\Item	EB	K	KA	KB	KC	L	LA	LB	LC	M	MA	MB
HFZ10	5.7	M3×0.5	5	16	23	M3×0.5	6	18	12	M3×0.5	6	11.5
HFZ16	7	M4×0.7	7	24	24.5	M4×0.7	8	22	15	M4×0.7	4.5	16
HFZ20	9	M5×0.8	8	30	29	M5×0.8	10	32	18	M5×0.8	8	18.5
HFZ25	12	M6×1.0	10	36	30	M6×1.0	12	40	22	M6×1.0	10	22
HFZ32	14	M6×1.0	10	46	40(49)	M6×1.0	12	46	26	M6×1.0	10	26
HFZ40	17	M8×1.25	12	56	49(62)	M8×1.25	16	56	32	M8×1.25	12	32

Model\Item	MC	N	NA	P	PA	PB	PC	UA(Opened)	UB(Closed)
HFZ10	27	Φ11 ^{+0.05} ₀	1.5	M3×0.5	7	19	10	15.5 ⁺² ₀	11.5 ⁻⁰ ₀
HFZ16	30	Φ17 ^{+0.05} ₀	1.5	M5×0.8	7.5	19	13	21 ⁺² ₀	15 ⁻⁰ ₀
HFZ20	35	Φ21 ^{+0.05} ₀	2	M5×0.8	9.5	23	15	26.5 ⁺² ₀	16.5 ⁻⁰ ₀
HFZ25	36.5	Φ26 ^{+0.05} ₀	2	M5×0.8	9	24	20	33.5 ⁺² ₀	19.5 ⁻⁰ ₀
HFZ32	48(57)	Φ34 ^{+0.05} ₀	2.5	M5×0.8	9.5	31(40)	24	48 ^{+2.5} ₀	26 ⁻⁰ ₀
HFZ40	58(71)	Φ42 ^{+0.05} ₀	2.5	M5×0.8	10.5	38(50)	28	60 ^{+2.5} ₀	30 ⁻⁰ ₀

[Note] The values in "()" in the above table are single acting type sizes.

Bottom mounting type(F type)

Φ6

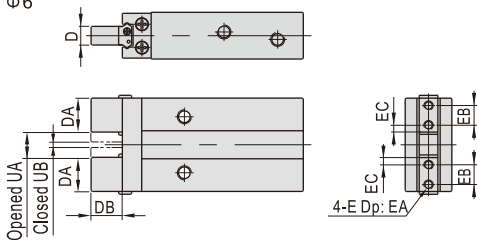

Model\Item	D	DA	DB	EA	EB	E
HFZ6-F	4 ^{-0.05} ₀	7.5	7	3	3.5	M2×0.4

Model\Item	UA(Opened)	UB(Closed)
HFZ6-F	5 ^{+1.5} ₀	1.8 ^{-0.5} ₀

Side mounting type(B type)

Φ6

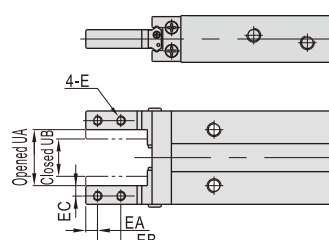

Model\Item	E	EA	EB	EC
HFZ6-B	M2×0.4	2.5	5	2

Model\Item	UA(Opened)	UB(Closed)
HFZ6-B	11 ⁺² ₀	8 ⁻⁰ ₀

Thru-hole mounting type(N type)

Φ6

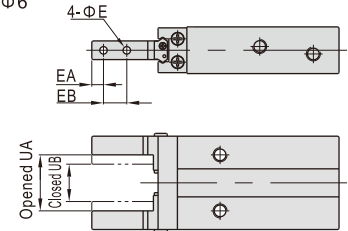

Model\Item	E	EA	EB
HFZ6-N	2.3	2.5	5

Model\Item	UA(Opened)	UB(Closed)
HFZ6-N	11 ⁺² ₀	8 ⁻⁰ ₀

[Note] The other dimensions are the same as standard type.

How to select product \ Installation and application

Please refer to HFK series for details.





Air gripper—HFK Series

Parallel style with guide track—roller bearing

Compendium of HFK Series

Six kinds of bore size and three kinds of type

Bore size: 10, 16, 20, 25, 32, 40,
HFK: Double acting
HFSK: Single acting and normally closed
HFTK: Single acting and normally opened

Integrated design of linear guide roller

Integrated design of linear guide roller,
high rigidity and high precision.

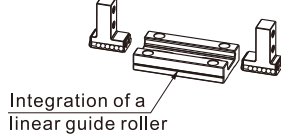

With positioning pin

A positioning pin is attached to the bottom
of the linear guide rail, which can prevent
the deviation of the positioning rail and body.

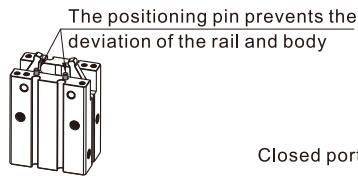

With squareness magnetic switch slots

The squareness magnetic switch slots convenient
to install DMSG(S)\CMSG type inducting switch.

With roundness magnetic switch slots

The roundness magnetic switch slots convenient
to install DMSH(S)\CMSH type inducting switch.

Seven kinds of finger type

Standard type

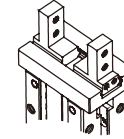

Narrow type(R)

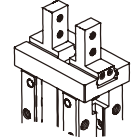

Side mounting
type(B)

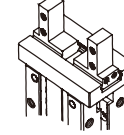

Side mounting and
narrow type(W)

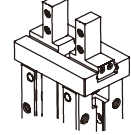

Thru.hole
mounting type(N)

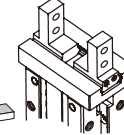

Thru.hole mounting
and narrow type(M)

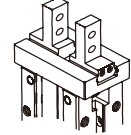

Bottom mounting
type(F)

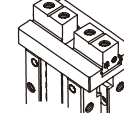

According to the actual using requirements of
customers, the initial position of clamping jaw
can be customized to meet the different needs
under different working conditions.

Can be mounted from three directions

With mounting holes on the side and tail.

Surface installation

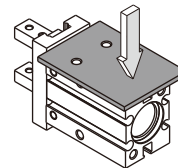

Tail installation

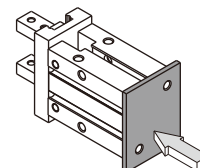

Front installation

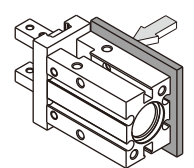

With positioning hole

The positioning hole can improve the precision and the
consistency of
repeated
dismounting and
positioning.

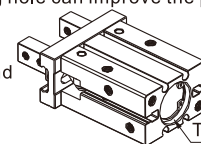

The positioning hole

Bore size (mm)		10	16	20	25	32	40	
Acting type		Double acting		Single acting				
Fluid		Air(to be filtered by 40μm filter element)						
Operating pressure	Double acting	Φ10	0.2~0.7MPa(28~100psi)(2.0~7.0bar)					
		Others	0.15~0.7MPa(22~100psi)(1.5~7.0bar)					
	Single acting	Φ10	0.35~0.7MPa(50~100psi)(3.5~7.0bar)					
		Others	0.25~0.7MPa(36~100psi)(2.5~7.0bar)					
Temperature °C		-20~70						
Lubrication		Not required						
Repeatability mm		±0.01			±0.02			
Max. frequency		180(c.p.m)			60(c.p.m)			
Sensor switches		DMSH\CMSH		DMSG\CMSG, DMSH\CMSH				
Port size		M3×0.5		M5×0.8				

Note) Refer to P524 for detail of sensor switch.



Air gripper(parallel style——roller bearing)

HFK Series



Symbol

HFK: Double acting

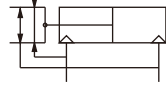

HFTK: Single acting and normally opened

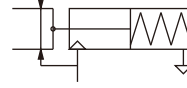

HFSK: Single acting and normally closed

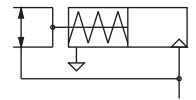

Gripping force and stroke

Acting type		Double acting(HFK)						Single acting_NO (HFTK)						Single acting_NC (HFSK)					
Bore size		10	16	20	25	32	40	10	16	20	25	32	40	10	16	20	25	32	40
Gripping force per finger Effective value(N)	External	11	34	45	69	160	255	7	27	35	55	133	220	-	-	-	-	-	-
	Internal	17	45	68	102	195	320	-	-	-	-	-	-	13	38	59	87	163	270
Opening/Closing stroke(Both sides)(mm)		4	6	10	14	22	30	4	6	10	14	22	30	4	6	10	14	22	30
Weight (g)	F Type	56	124	236	418	750	1340	57	125	238	420	799	1437	57	125	238	420	799	1437
	Others	56	124	236	428	729	1268	57	125	238	430	778	1365	57	125	238	430	778	1365

[Note] The gripping force in the above table is in the working pressure of 0.5MPa, and with a gripping point of L=20mm.

Add) Please refer to page 464 for the definition of "L".

Ordering code

HFK 20 □

① ② ③

① Model	② Bore size	③ Finger type			
HFK: Air finger(Double acting)	10 16 20 25 32 40	Blank: Standard 	B: Side mounting type 	R: Narrow type 	F: Bottom mounting type
HFSK: Air finger (Single acting and normally closed)					
HFTK: Air finger (Single acting and normally opened)	10 16 20 25	N: Thru.hole mounting type 	W: Side mounting and narrow type 	M: Thru.hole mounting and narrow type 	HFK series are all attached with magnet.

Inner structure and material of major parts

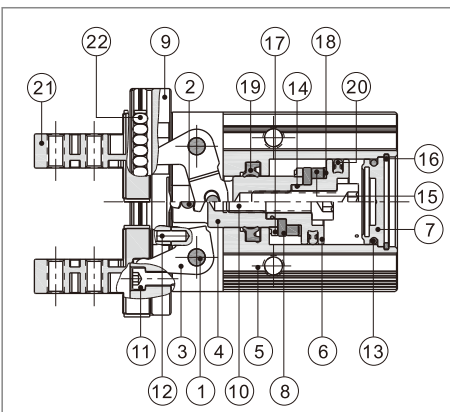

NO.	Item	Material	NO.	Item	Material
1	Pin	Stainless steel	12	Pin	Bearing steel
2	Pin	Stainless steel	13	O-ring	NBR
3	Curved bar	Stainless steel	14	O-ring	NBR
4	Piston rod	Aluminum alloy/Stainless steel	15	Magnet	Sintered metal(Neodymium-iron-boron)
5	Body	Aluminum alloy	16	C clip	Spring steel
6	Piston	Aluminum alloy/Stainless steel	17	Bumper	TPU
7	Back cover	Brass/Aluminum alloy	18	Magnet washer	NBR
8	Magnet fixed flake	Aluminum alloy/Stainless steel	19	Rod packing	NBR
9	Bearing steel	Stainless steel	20	Piston seal	NBR
10	Countersink screw	Carbon steel	21	Clamping jaw	Bearing steel
11	Countersink screw	Carbon steel	22	Guide roller	Bearing steel

Air gripper(parallel style——roller bearing)



HFK Series

Dimensions

Standard

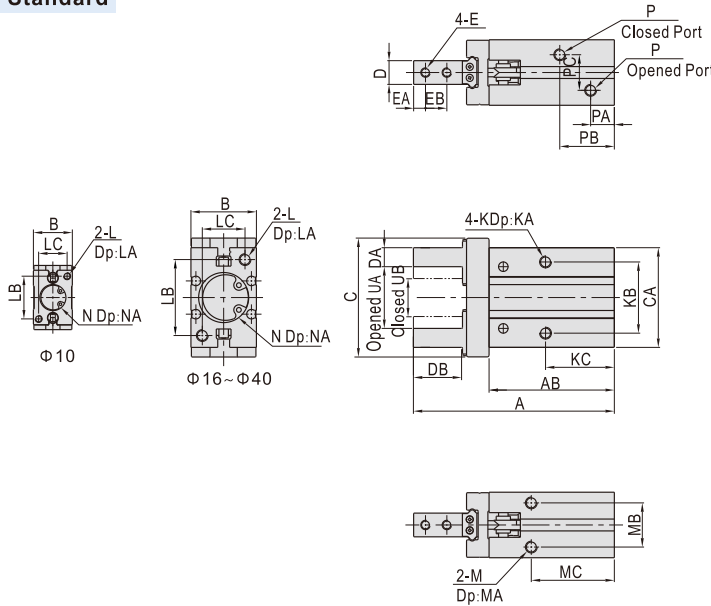

Model/Item	A	AB	B	C	CA	D	DA	DB	E	EA
HFK10	57	37.5	16.5	30	23	5 ^{-0.05} ₀	4 ^{-0.05} ₀	12	M2.5×0.45	3
HFK16	67.5	42.5	23.5	39	30.5	8 ^{-0.05} ₀	5 ^{-0.05} ₀	15	M3×0.5	4
HFK20	85	53	27.5	53	42	10 ^{-0.05} ₀	8 ^{-0.05} ₀	20	M4×0.7	5
HFK25	103	64	33.5	71	52	12 ^{-0.05} ₀	10 ^{-0.05} ₀	25	M5×0.8	6
HFK32	113(122)	67(76)	40	106	60	15 ^{-0.05} ₀	12 ^{-0.05} ₀	29	M6×1.0	7
HFK40	139(152)	83(96)	48	132	72	18 ^{-0.05} ₀	14 ^{-0.05} ₀	36	M8×1.25	9

Model/Item	EB	K	KA	KB	KC	L	LA	LB	LC	M	MA	MB
HFK10	5.7	M3×0.5	5	16	23	M3×0.5	6	18	12	M3×0.5	6	11.5
HFK16	7	M4×0.7	7	24	24.5	M4×0.7	8	22	15	M4×0.7	4.5	16
HFK20	9	M5×0.8	8	30	29	M5×0.8	10	32	18	M5×0.8	8	18.5
HFK25	12	M6×1.0	10	36	30	M6×1.0	12	40	22	M6×1.0	10	22
HFK32	14	M6×1.0	10	46	40(49)	M6×1.0	12	46	26	M6×1.0	10	26
HFK40	17	M8×1.25	12	56	49(62)	M8×1.25	16	56	32	M8×1.25	12	32

Model/Item	MC	N	NA	P	PA	PB	PC	UA(Opened)	UB(Closed)
HFK10	27	Φ11 ^{+0.05} ₀	1.5	M3×0.5	7	19	10	15.5 ⁺² ₀	11.5 ⁻⁰ ₀
HFK16	30	Φ17 ^{+0.05} ₀	1.5	M5×0.8	7.5	19	13	21 ⁺² ₀	15 ⁻⁰ ₀
HFK20	35	Φ21 ^{+0.05} ₀	2	M5×0.8	9.5	23	15	26.5 ⁺² ₀	16.5 ⁻⁰ ₀
HFK25	36.5	Φ26 ^{+0.05} ₀	2	M5×0.8	9	24	20	33.5 ⁺² ₀	19.5 ⁻⁰ ₀
HFK32	48(57)	Φ34 ^{+0.05} ₀	2.5	M5×0.8	9.5	31(40)	24	48 ^{+2.5} ₀	26 ⁻⁰ ₀
HFK40	58(71)	Φ42 ^{+0.05} ₀	2.5	M5×0.8	10.5	38(50)	28	60 ^{+2.5} ₀	30 ⁻⁰ ₀

[Note] The values in "()" in the above table are single acting type sizes.

Narrow type(R type)

Φ10~Φ25

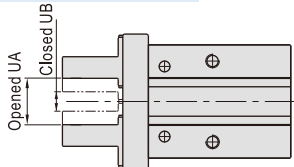

Model/Item	UA(Opened)	UB(Closed)
HFK10-R	10 ⁺² ₀	6 ⁻⁰ ₀
HFK16-R	12.5 ⁺² ₀	6.5 ⁻⁰ ₀
HFK20-R	17 ⁺² ₀	7 ⁻⁰ ₀
HFK25-R	23 ^{+2.5} ₀	9 ⁻⁰ ₀

Side mounting type(B type)

Φ10~Φ40

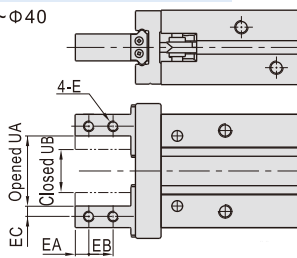

Model/Item	E	EA	EB	EC	UA(Opened)	UB(Closed)
HFK10-B	M2.5×0.45	3	5.7	2	15.5 ⁺² ₀	11.5 ⁻⁰ ₀
HFK16-B	M3×0.5	4	7	2.5	21 ⁺² ₀	15 ⁻⁰ ₀
HFK20-B	M4×0.7	5	9	4	26.5 ⁺² ₀	16.5 ⁻⁰ ₀
HFK25-B	M5×0.8	6	12	5	33.5 ⁺² ₀	19.5 ⁻⁰ ₀
HFK32-B	M6×1.0	7	14	6	48 ^{+2.5} ₀	26 ⁻⁰ ₀
HFK40-B	M8×1.25	9	17	7	60 ^{+2.5} ₀	30 ⁻⁰ ₀

Thru-hole mounting type(N type)

Φ10~Φ40

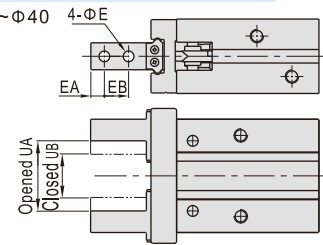

Model/Item	E	EA	EB	UA(Opened)	UB(Closed)
HFK10-N	2.8	3	5.7	15.5 ⁺² ₀	11.5 ⁻⁰ ₀
HFK16-N	3.3	4	7	21 ⁺² ₀	15 ⁻⁰ ₀
HFK20-N	4.5	5	9	26.5 ⁺² ₀	16.5 ⁻⁰ ₀
HFK25-N	5.5	6	12	33.5 ⁺² ₀	19.5 ⁻⁰ ₀
HFK32-N	6.5	7	14	48 ^{+2.5} ₀	26 ⁻⁰ ₀
HFK40-N	9	9	17	60 ^{+2.5} ₀	30 ⁻⁰ ₀

Bottom mounting type(F type)

Φ10~Φ40

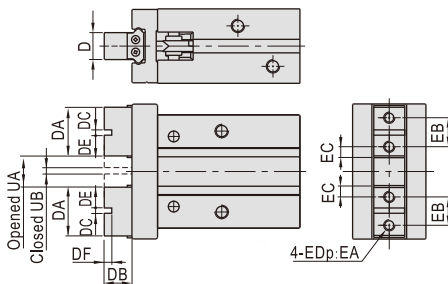

Model/Item	D	DA	DB	DC	DE	E
HFK10-F	5 ^{-0.05} ₀	11	5	2 ^{+0.04} ₀	4.5	M2.5×0.45
HFK16-F	8 ^{-0.05} ₀	14	8	2.5 ^{+0.04} ₀	5.8	M3×0.5
HFK20-F	10 ^{-0.05} ₀	18	10.5	3 ^{+0.04} ₀	7.5	M4×0.7
HFK25-F	12 ^{-0.05} ₀	22	13	4 ^{+0.04} ₀	9	M5×0.8
HFK32-F	15 ^{-0.05} ₀	34.5	18	5 ^{+0.04} ₀	14.8	M6×1.0
HFK40-F	18 ^{-0.05} ₀	41.5	22	6 ^{+0.04} ₀	17.7	M8×1.25

Model/Item	DF	EA	EB	EC	UA(Opened)	UB(Closed)
HFK10-F	2	4	6	2.45	5.5 ⁺² ₀	1.8 ^{-0.5} ₀
HFK16-F	2.5	6	8	3.05	7.5 ⁺² ₀	1.8 ^{-0.5} ₀
HFK20-F	3	8	10	3.95	11.5 ⁺² ₀	1.8 ^{-0.5} ₀
HFK25-F	4	10	12	4.9	16 ^{+2.5} ₀	2.4 ^{-0.5} ₀
HFK32-F	5	12	20	7.3	25 ^{+2.5} ₀	3.4 ^{-0.5} ₀
HFK40-F	6	16	24	8.7	33 ⁺³ ₀	3.4 ^{-0.5} ₀

Side mounting and narrow type(W type)

Φ10~Φ25

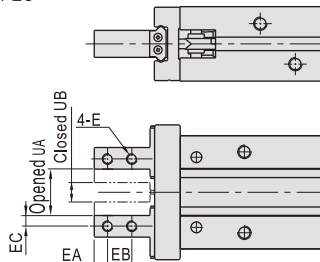

Model/Item	E	EA	EB	EC	UA(Opened)	UB(Closed)
HFK10-W	M2.5×0.45	3	5.7	2	10 ⁺² ₀	6 ⁻⁰ ₀
HFK16-W	M3×0.5	4	7	2.5	12.5 ⁺² ₀	6.5 ⁻⁰ ₀
HFK20-W	M4×0.7	5	9	4	17 ⁺² ₀	7 ⁻⁰ ₀
HFK25-W	M5×0.8	6	12	5	23 ^{+2.5} ₀	9 ⁻⁰ ₀

Thru-hole mounting and narrow type(M type)

Φ10~Φ25

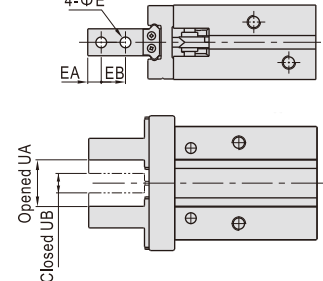

Model/Item	E	EA	EB	UA(Opened)	UB(Closed)
HFK10-M	2.8	3	5.7	10 ⁺² ₀	6 ⁻⁰ ₀
HFK16-M	3.3	4	7	12.5 ⁺² ₀	6.5 ⁻⁰ ₀
HFK20-M	4.5	5	9	17 ⁺² ₀	7 ⁻⁰ ₀
HFK25-M	5.5	6	12	23 ^{+2.5} ₀	9 ⁻⁰ ₀

[Note] The other dimensions are the same as standard type.



HFZ, HFK Series

How to select product

Please select pneumatic finger according to the following steps:

- ① The selection of the effective gripping force
- ② the confirmation of the gripping point
- ③ the confirmation of the external force put on the gripping jaw

1. The selection of the gripping force

The gripping work-pieces shown below, on the impact condition of ordinary handling state, taking safety coefficient $a=4$, have a gripping force that is more than 10-20 times of the mass of the gripped objects.

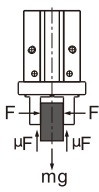

The work-pieces as shown in the left :

F: Gripping force (N)
 μ : friction coefficient between fittings and work-pieces.
 m: mass of work-pieces
 g: acceleration of gravity (=9.8m/s²)

The condition that the work-pieces won't drop is: $2 \times \mu F > mg$

$$\text{so: } F > \frac{mg}{2 \times \mu}$$

Safety coefficient is a, so F is:

$$F = \frac{mg}{2 \times \mu} \times a$$

$\mu=0.2$

$$F = \frac{mg}{2 \times 0.2} \times 4 = 10 \times mg$$

10 times of the mass of the gripped objects

$\mu=0.1$

$$F = \frac{mg}{2 \times 0.1} \times 4 = 20 \times mg$$

20 times of the mass of the gripped objects

Note) If the friction coefficient $\mu > 0.2$, for safety, please also select clamping force according to the principle of 10~20 times of the mass of the clamped objects. As for large acceleration and shock, it requires for greater safety coefficient.

1.1) The actual gripping force must be within the effective gripping forces of different pneumatic fingers specifications shown in the below chart.

Double acting type closed gripping force

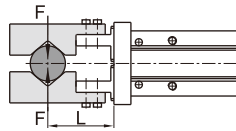
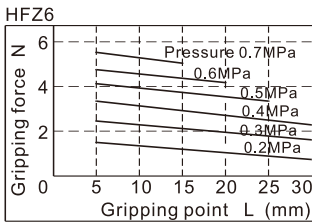

Double acting type opened gripping force

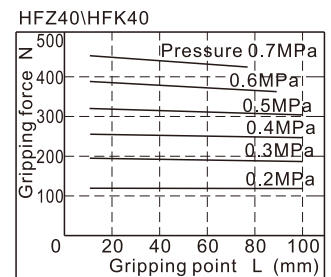
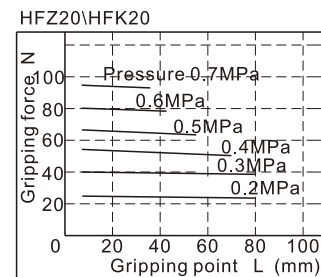
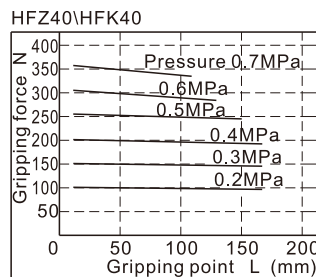
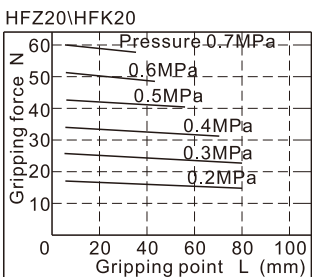
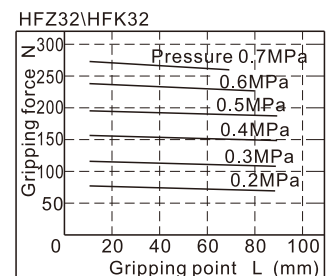
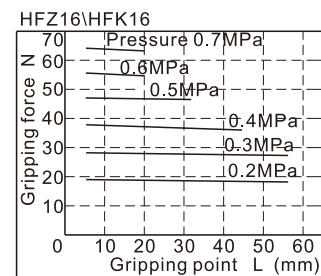
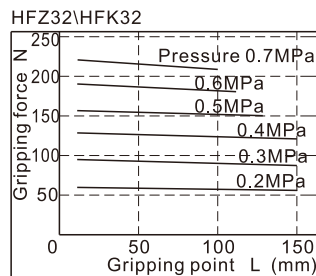
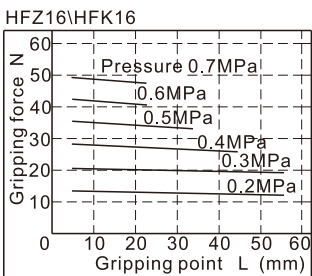
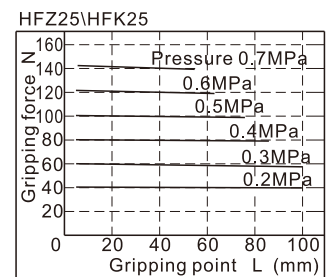
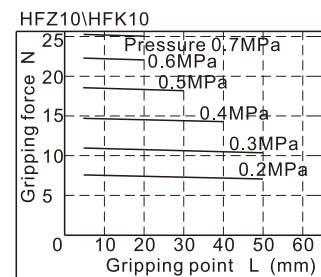
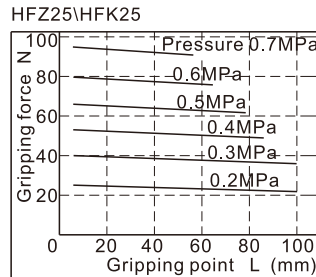
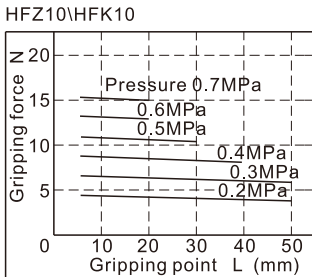
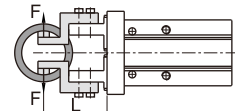
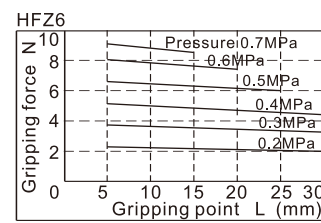

HFZ, HFK Series

Single acting normally opened gripping force

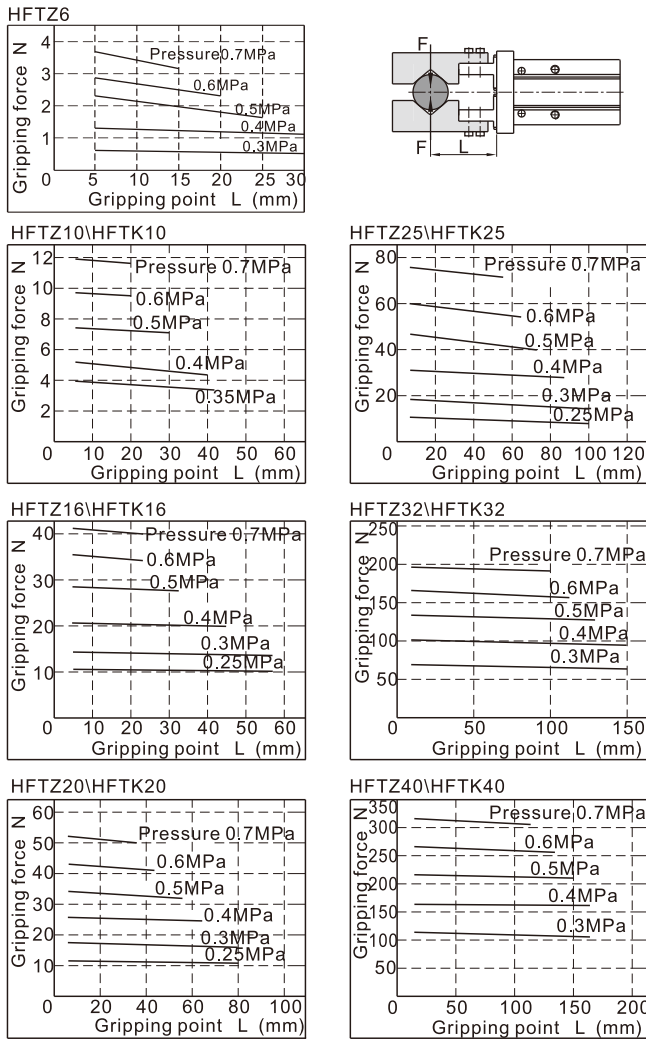

Single acting normally closed clamping force

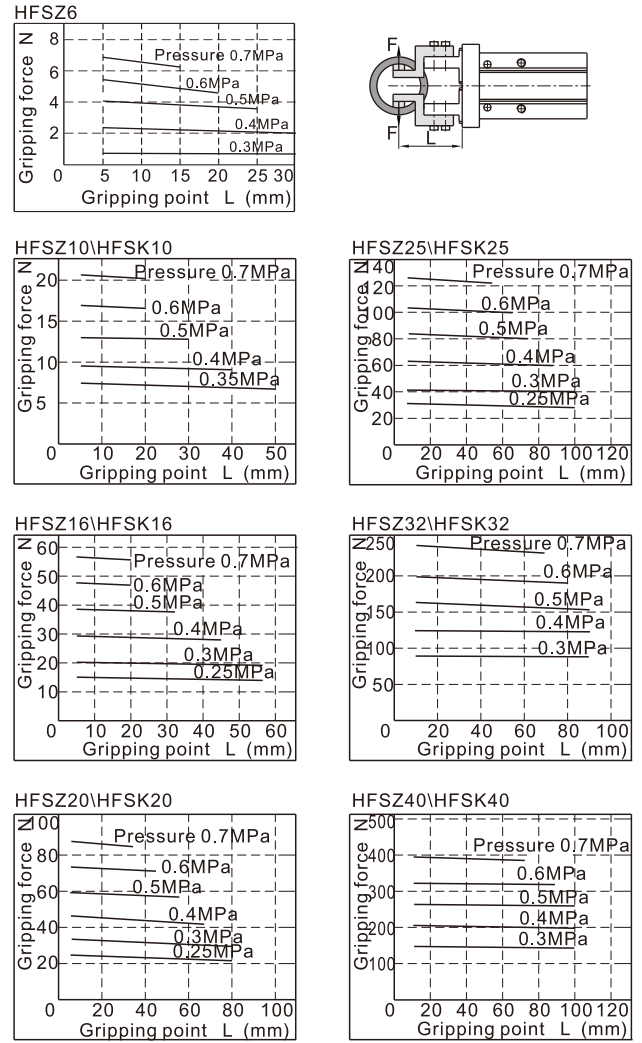

2. The selection of the gripping point

2.1) Please select the gripping point within the limited field shown below.

Over the limits, gripping jaws would be subjected to excessive torque loads, and lead to short life of the air gripper.

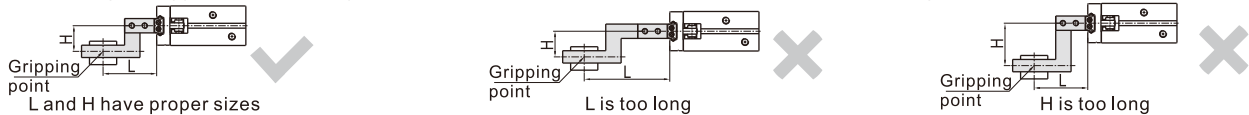

2.2) In the allowable range of gripping point, it is better to design for short and light fittings. If the fittings are long and heavy, the inertia force when the finger is open and close will become larger, and the performance of gripping jaw will be degraded, at the same time it will affect the life.

2.3) When the gripped object is very fine and thin, you have to equip with gap between fittings. If not, there will be unstable clamp, resulting in a position offset and adverse clamping and so on.



3. The confirmation of the external force put on the gripping jaw.

Bore size	The allowed vertical loads Fv(N)		Max. permissible torque(Nm)			The calculation of allowable forces when moment loads work	Examples of calculation
	HFZ	HFK	Mp	My	Mr		
6	10	-	0.04	0.04	0.08	$\text{Allowable load(N)} = \frac{\text{M(Maximum permissible moment)(N.m)}}{L \times 10^{-3}}$ Unit conversion constant	In the guide rail of HFK16, the external force of the pitching moment static loads put on the point of L=30mm is f=10 N, $\text{Allowable load } F = \frac{0.68}{30 \times 10^{-3}} = 22.7(\text{N})$ Actual load f=10(N)<22.7(N) To meet the using requirements
10	58	87	0.26	0.26	0.53		
16	98	147	0.68	0.68	1.36		
20	147	221	1.32	1.32	2.65		
25	255	382	1.94	1.94	3.88		
32	343	514	3	3	6		
40	490	735	4.5	4.5	9		

[Note] The loads and torque values of said are all static values.

Air gripper(parallel style——roller bearing)

HFZ, HFK Series

The range of the closed gripping points

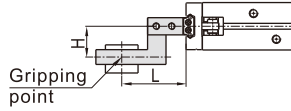
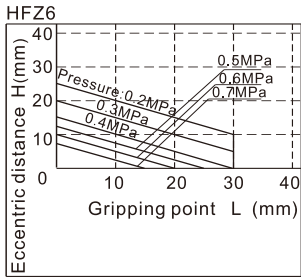

The range of the opened clamping point

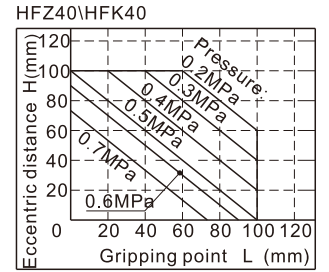
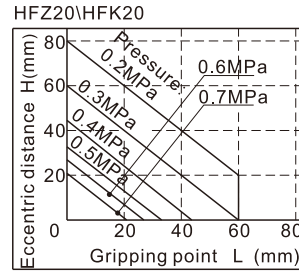
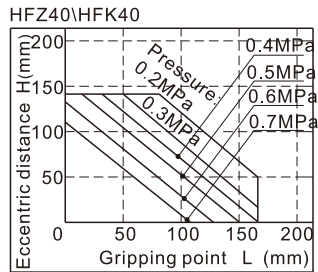
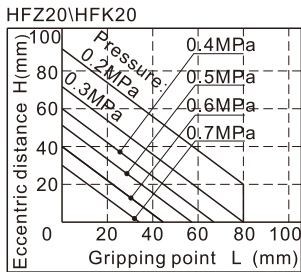
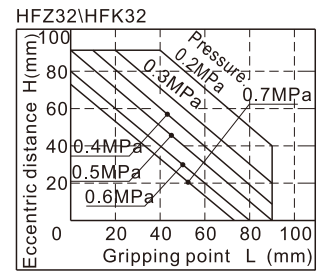
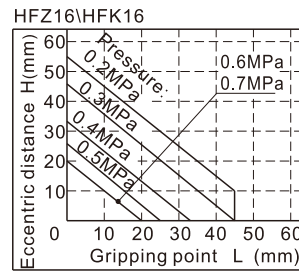
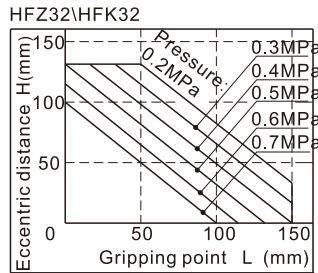
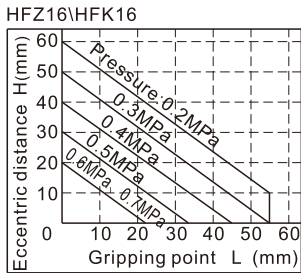
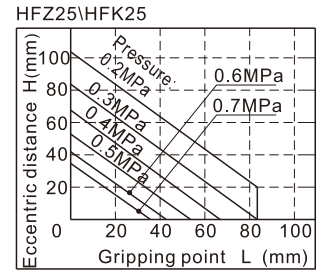
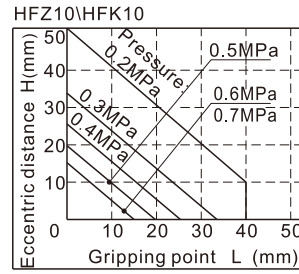
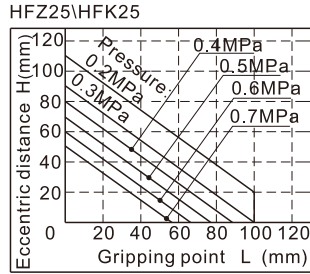
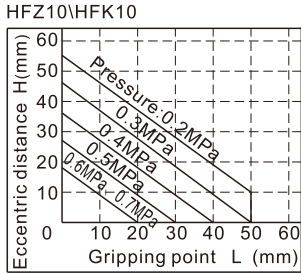
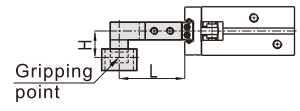
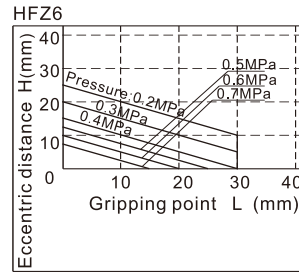

Air gripper(parallel style——roller bearing)

HFZ, HFK Series

Installation and application

1. Due to the abrupt changes, the circuit pressure is low, which will lead to the decrease of the gripping force and falling of the work-pieces. In order to avoid the harm to the human body and damage to the equipment, anti-dropping device must be equipped.
2. Don't use the air gripper under strong external force and impact force.
3. Please contact with us when the single acting type clamps only with the spring force.
4. When install and fix the air gripper, avoid falling down, collision and damage.
5. When fixing the gripping jaw parts, don't twist the gripping jaw.
6. There are several kinds of installation method, and the locking torque of fastening screw must be within the prescribed torque range shown in the below chart. If the locking torque is too large, it will cause the dysfunctional. If the locking torque is too small, it will cause the position deviation and fall.

Tail installation type

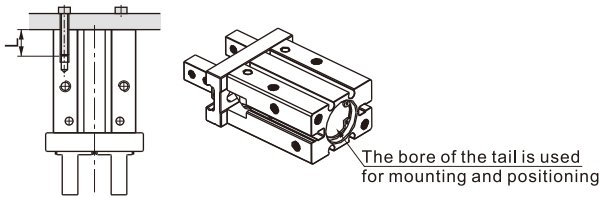

Bore size	The bolts type	Max. locking moment	Max. screwed depth	The aperture of the positioning bore	The depth of the positioning bore
10	M3×0.5	0.88N.m	6mm	Φ11mm $^{+0.05}_0$	1.5mm
16	M4×0.7	2.1N.m	8mm	Φ17mm $^{+0.05}_0$	1.5mm
20	M5×0.8	4.3N.m	10mm	Φ21mm $^{+0.05}_0$	2mm
25	M6×1.0	7.3N.m	12mm	Φ26mm $^{+0.05}_0$	2mm
32	M6×1.0	7.9N.m	12mm	Φ34mm $^{+0.05}_0$	2.5mm
40	M8×1.25	17.7N.m	16mm	Φ42mm $^{+0.05}_0$	2.5mm

The installation of the front threaded hole

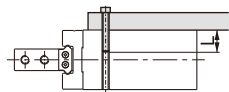

Bore size	The bolts type	Max. locking moment(Nm)	Max. screwed depth(mm)
6	M3×0.5	0.88	10
10	M3×0.5	0.69	5
16	M4×0.7	2.1	7
20	M5×0.8	4.3	8
25	M6×1.0	7.3	10
32	M6×1.0	7.9	12
40	M8×1.25	17.7	12

The installation of the front through hole

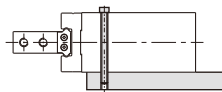

Bore size	The bolts type	Max. locking moment (Nm)	Max. screwed depth (mm)
6	M2.5×0.45	0.49	-
10	M2.5×0.45	0.49	5
16	M3×0.5	0.88	8
20	M4×0.7	2.1	10
25	M5×0.5	4.3	12
32	M5×0.8	4.3	13
40	M6×1.0	7.3	16

Surface installation type

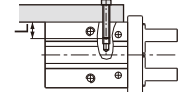

Bore size	The bolts type	Max. locking moment (Nm)	Max. screwed depth (mm)
10	M3×0.5	0.9	6
16	M4×0.7	1.6	4.5
20	M5×0.8	3.3	8
25	M6×1.0	5.9	10
32	M6×1.0	5.9	10
40	M8×1.25	13.7	12

7. The installation method of the gripping jaw fittings
When install the gripping jaw fittings, you have to pay particular attention that you can only hold the gripping jaw by using spanner, and then lock the screws with allen wrench. Never clamp the body directly and then lock the screws, otherwise the parts will be easily damaged.

Bore size	The bolts type	Max. locking moment (Nm)
6	M2×0.4	0.15
10	M2.5×0.45	0.31
16	M3×0.5	0.59
20	M4×0.7	1.4
25	M5×0.8	2.8
32	M6×1.0	4.9
40	M8×1.25	11.8

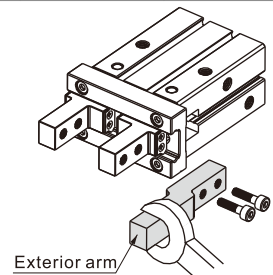

8. Confirm that there is no external forces exerted on the gripping jaw.
Transverse load acts on the gripping jaw, which will cause impact load and leads to the shaking and damage of gripping jaw. Equip with gaps so that the air gripper will not crash into work-pieces and accessories at the end of its trip.

- 8.1) The end of stroke under the open state of air gripper

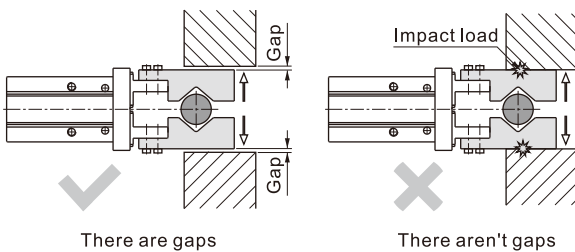

- 8.2) The end of stroke under the move state of air gripper

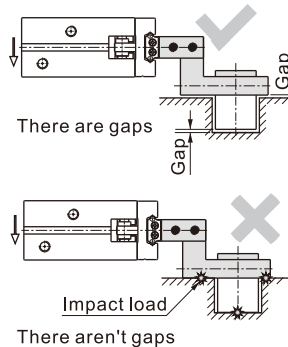

- 8.3) Reverse motion state
When reverse motion state, the gripping point must be precision, otherwise in the reverse motion state the air gripper maybe impact with ambience and will cause impact load.

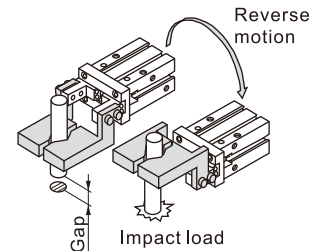

9. When the work-pieces are inserted, the center line should be coaxial, no offset, in case there are external force generated on gripping jaw. When testing, it is specially required that the manual operation should be reduced, the pressure should be used to run it at a low speed, and guarantee the safety and no impact.

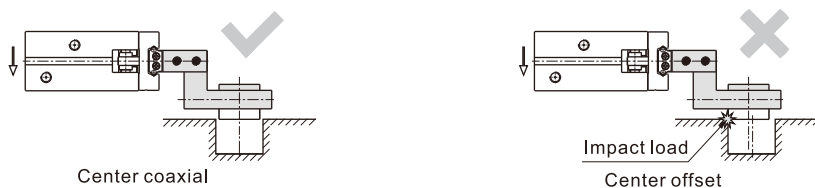

10. Please use the flow control valve to adjust the opening and closing speed of gripping jaw if too fast.
11. People can not enter the movement path of air gripper and articles can not be placed on the path too.
12. Before removing the air gripper, please confirm that it is out of working state, and then discharge of compressed air.