

Operating Instructions

iTEMP TMT82

Dual-input temperature transmitter

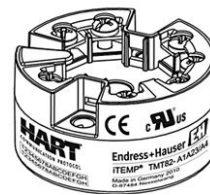
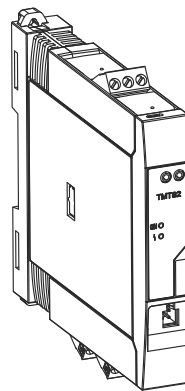

Table of contents

1	Important document information	4	9	Maintenance	33
1.1	Function of document and how to use	4	10	Accessories	34
1.2	Symbols	4	10.1	Device-specific accessories	34
1.3	Tool symbols	6	10.2	Communication-specific accessories	34
1.4	Further standard device documentation	6	10.3	Service-specific accessories	35
1.5	Registered trademarks	6	10.4	System components	35
2	Basic safety instructions	7	11	Diagnostics and troubleshooting	37
2.1	Requirements for the personnel	7	11.1	Troubleshooting	37
2.2	Designated use	7	11.2	Diagnostics events	39
2.3	Operational safety	7	11.3	Spare parts	42
3	Identification	8	11.4	Return	43
3.1	Device designation	8	11.5	Disposal	43
3.2	Scope of delivery	9	11.6	Software history and overview of compatibility	43
3.3	Certificates and approvals	9	12	Technical data	44
4	Installation	11	13	Operating menu and parameter description	60
4.1	Incoming acceptance, transport, storage	11	13.1	"Setup" menu	66
4.2	Installation conditions	11	13.2	"Diagnostics" menu	86
4.3	Installation	11	13.3	"Expert" menu	94
4.4	Post-installation check	16	Index	112	
5	Wiring	17			
5.1	Quick wiring guide	17			
5.2	Connecting the sensor cables	18			
5.3	Connecting the power supply and signal cables	19			
5.4	Shielding and grounding	20			
5.5	Post-connection check	21			
6	Operating options	22			
6.1	Overview of operation options	22			
6.2	Structure and function of the operating menu	23			
6.3	Measured value display and operating elements	25			
6.4	Access to the operating menu via the operating tool	27			
7	Integrating the transmitter via the HART® protocol	30			
7.1	HART device variables and measured values	30			
7.2	Device variables and measured values	31			
7.3	Supported HART® commands	31			
8	Commissioning	33			
8.1	Post-installation check	33			
8.2	Switching on the transmitter	33			
8.3	Enabling configuration	33			

1 Important document information

1.1 Function of document and how to use

1.1.1 Document function

These Operating Instructions contain all the information that is required in various phases of the life cycle of the device: from product identification, incoming acceptance and storage, to mounting, connection, operation and commissioning through to troubleshooting, maintenance and disposal.

1.1.2 Safety Instructions (XA)



When using in hazardous areas, compliance with national regulations is mandatory. Separate Ex-specific documentation is provided for measuring systems that are used in hazardous areas. This documentation is an integral part of these Operating Instructions. The installation specifications, connection data and safety instructions it contains must be strictly observed! Make sure that you use the right Ex-specific documentation for the right device with approval for use in hazardous areas! The number of the specific Ex documentation (XA...) is provided on the nameplate. If the two numbers (on the Ex documentation and the nameplate) are identical, then you may use this Ex-specific documentation.

1.1.3 Functional safety



 Please refer to Safety Manual SD01172T/09 for the use of approved devices in protective systems according to IEC 61508.



1.2 Symbols

1.2.1 Safety symbols







Symbol	Meaning
 A0011189-EN	DANGER! This symbol alerts you to a dangerous situation. Failure to avoid this situation will result in serious or fatal injury.
 A0011191-EN	CAUTION! This symbol alerts you to a dangerous situation. Failure to avoid this situation can result in minor or medium injury.
 A0011192-EN	NOTE! This symbol contains information on procedures and other facts which do not result in personal injury.

1.2.2 Electrical symbols



Symbol	Meaning
 A0011197	Direct current A terminal to which DC voltage is applied or through which direct current flows.
 A0011198	Alternating current A terminal to which alternating voltage (sine-wave) is applied or through which alternating current flows.

Symbol	Meaning
 A0011200	Ground connection A grounded terminal which, as far as the operator is concerned, is grounded via a grounding system.
 A0011199	Protective ground connection A terminal which must be connected to ground prior to establishing any other connections.
 A0011201	Equipotential connection A connection that has to be connected to the plant grounding system: This may be a potential equalization line or a star grounding system depending on national or company codes of practice.





1.2.3 Symbols and notation for certain types of information

Symbol	Meaning
 A0011182	Allowed Indicates procedures, processes or actions that are allowed.
 A0011183	Preferred Indicates procedures, processes or actions that are preferred.
 A0011184	Forbidden Indicates procedures, processes or actions that are forbidden.
 A0011193	Tip Indicates additional information.
 A0011194	Reference to documentation Refers to the corresponding device documentation.
 A0011195	Reference to page Refers to the corresponding page number.
 A0011196	Reference to graphic Refers to the corresponding graphic number and page number.
1., 2., 3.	Series of steps
✓	Result of a sequence of actions

1.2.4 Symbols and notation in graphics

Symbol	Meaning
1,2,3 ...	Item numbers
A, B, C, ...	Views
A-A, B-B, C-C, ...	Sections
 A0011187	Hazardous area Indicates a hazardous area.
 A0011188	Safe area (non-hazardous area) Indicates the non-hazardous area.

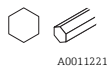
1.3 Tool symbols

Symbol	Meaning
 A0011220	Flat blade screwdriver
 A0011219	Crosstip screwdriver
 A0011221	Allen key
 A0011222	Open-ended wrench
 A0013442	Torx screwdriver

1.4 Further standard device documentation

Document	Purpose and content of the document
Technical Information TI01010T/09/en	Planning aid for your device The document contains all the technical data on the device and provides an overview of the accessories and other products that can be ordered for the device.
Brief Operating Instructions KA01095T/09/en	Guide that takes you quickly to the 1st measured value The Brief Operating Instructions contain all the essential information from incoming acceptance to initial commissioning.

 The document types listed are available:
In the Download Area of the Endress+Hauser Internet site: www.endress.com →
Download

1.5 Registered trademarks

HART®
Registered trademark of the HART® FieldComm Group

2 Basic safety instructions

2.1 Requirements for the personnel

The personnel for installation, commissioning, diagnostics and maintenance must fulfill the following requirements:

- ▶ Trained, qualified specialists must have a relevant qualification for this specific function and task
- ▶ Are authorized by the plant owner/operator
- ▶ Are familiar with federal/national regulations
- ▶ Before beginning work, the specialist staff must have read and understood the instructions in the Operating Instructions and supplementary documentation as well as in the certificates (depending on the application)
- ▶ Following instructions and basic conditions

The operating personnel must fulfill the following requirements:

- ▶ Being instructed and authorized according to the requirements of the task by the facility's owner-operator
- ▶ Following the instructions in these Operating Instructions

2.2 Designated use

The device is a universal and user-configurable temperature transmitter with either one or two sensor inputs for a resistance thermometer (RTD), thermocouples (TC), resistance and voltage transmitters. The head transmitter version of the device is intended for mounting in a flat-face terminal head as per DIN EN 50446. It is also possible to mount the device on a DIN rail using the optional DIN rail clip. The device is also optionally available in a version suitable for DIN rail mounting as per IEC 60715 (TH35).

The manufacturer is not liable for damage caused by improper or non-designated use.

2.3 Operational safety

- ▶ Operate the device in proper technical condition and fail-safe condition only.
- ▶ The operator is responsible for interference-free operation of the device.

Hazardous area

To eliminate a danger for persons or for the facility when the device is used in the hazardous area (e.g. explosion protection or safety equipment):

- ▶ Based on the technical data on the nameplate, check whether the ordered device is permitted for the intended use in the hazardous area. The nameplate can be found on the side of the transmitter housing.
- ▶ Observe the specifications in the separate supplementary documentation that is an integral part of these Instructions.

Electromagnetic compatibility

The measuring system complies with the general safety requirements as per EN 61010-1, the EMC requirements as per the IEC/EN 61326 series and the NAMUR recommendations NE 21 and NE 89.

NOTICE

- ▶ The unit must only be powered by a power supply that operates using an energy-limited electric circuit that is compliant with IEC 61010-1, "SELV or Class 2 circuit".

3 Identification

3.1 Device designation

The following options are available for identification of the device:

- Nameplate specifications
- Enter the serial number from the nameplate in the *W@M Device Viewer* (www.endress.com/deviceviewer): All data relating to the device and an overview of the Technical Documentation supplied with the device are displayed.

3.1.1 Nameplate

The right device?

Compare and check the data on the nameplate of the device against the requirements of the measuring point:

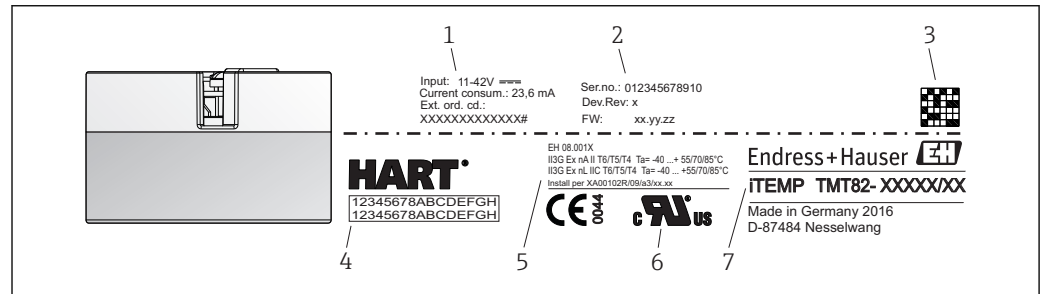

A0014561

- 1 Nameplate of the head transmitter (example, Ex version)
- 1 Power supply, current consumption and extended order code
 - 2 Serial number, device revision and firmware version
 - 3 Data Matrix 2D code
 - 4 2 lines for the TAG name
 - 5 Approval in hazardous area with number of the relevant Ex documentation (XA...)
 - 6 Approvals with symbols
 - 7 Order code and manufacturer ID

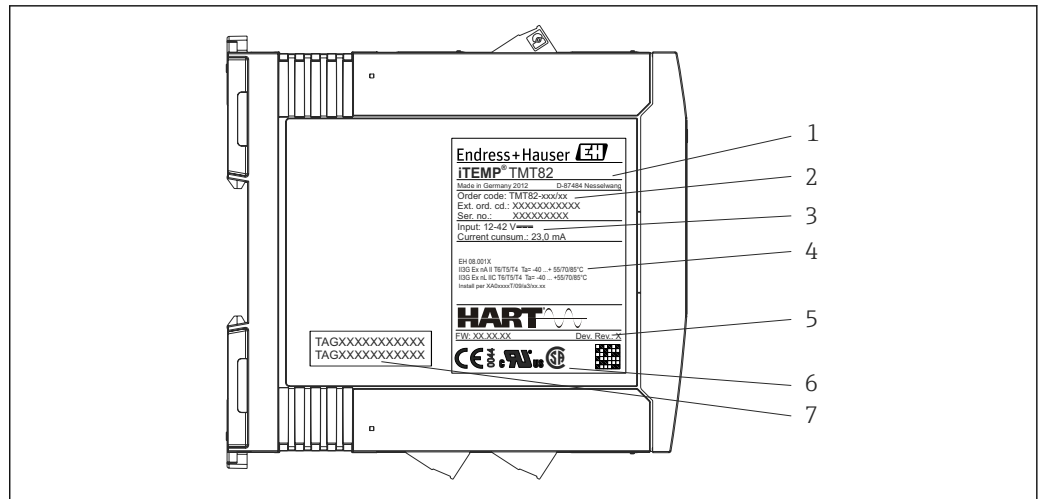



A0017924

 2 Nameplate of DIN rail transmitter (example, Ex version)

- 1 Product description and manufacturer ID
- 2 Order code, extended order code and serial number
- 3 Power supply and current consumption
- 4 Approval in hazardous area with number of the relevant Ex documentation (XA...)
- 5 Firmware version and device version
- 6 Approval logos
- 7 2 lines for the TAG name

3.2 Scope of delivery

The scope of delivery of the device comprises:

- Temperature transmitter
- Mounting material (head transmitter)
- Hard copy of multi-language Brief Operating Instructions
- Functional Safety Manual (SIL mode)
- Additional documentation for devices which are suitable for use in the hazardous area (  ), such as Safety Instructions (XA), Control or Installation Drawings (ZD).

3.3 Certificates and approvals

The device left the factory in a safe operating condition. The device complies with the requirements of the standards EN 61 010-1 "Safety Requirements for Electrical Equipment for Measurement, Control, and Laboratory Use" and with the EMC requirements as per the IEC/EN 61326 series.

3.3.1 CE/EAC mark, declaration of conformity

The device meets the legal requirements of the EU/EEU guidelines. The manufacturer confirms that the device is compliant with the relevant guidelines by applying the CE/EAC mark.

3.3.2 HART® protocol certification

The temperature transmitter is registered by the HART® FieldComm Group. The device meets the requirements of the HART Communication Protocol Specifications, Revision 7 (HCF 7.4).

3.3.3 Functional safety

The two device versions (head transmitter/DIN rail device) are optionally available for use in safety systems as per IEC 61508.

- SIL 2: Hardware version
- SIL 3: Software version

4 Installation

4.1 Incoming acceptance, transport, storage

4.1.1 Incoming acceptance

- Is the packaging or content damaged?
- Is the delivery complete? Compare the scope of delivery against the information on your order form.

4.1.2 Transport and storage

- Pack the device in such a way as to protect it reliably against impact for storage (and transportation). The original packaging provides optimum protection.
- Permitted storage temperature:
 - Head transmitter: -50 to +100 °C (-58 to +212 °F)
 - DIN rail transmitter: -40 to +100 °C (-40 to +212 °F)



4.2 Installation conditions

4.2.1 Dimensions

The dimensions of the device are provided in the "Technical data" section →  44.

4.2.2 Mounting location

- Head transmitter:
 - In the terminal head, flat face, as per DIN EN 50446, direct mounting on insert with cable entry (middle hole 7 mm)
 - In the field housing, separated from the process →  34
- DIN rail transmitter:
Designed for mounting on DIN rail (IEC 60715 TH35).

 It is also possible to mount the head transmitter on a DIN rail as per IEC 60715 using the DIN rail clip →  34 accessory.

Information about the conditions (such as the ambient temperature, degree of protection, climate class etc.) that must be present at the installation point so that the device can be mounted correctly is provided in the "Technical data" section →  44.

When using in hazardous areas, the limit values of the certificates and approvals must be observed (see Ex Safety Instructions).

4.3 Installation

A Phillips head screwdriver is required to mount the head transmitter.

NOTICE

Do not overtighten the mounting screws as this could damage the head transmitter.

- ▶ Maximum torque = 1 Nm (¾ pound-feet).

4.3.1 Mounting the head transmitter

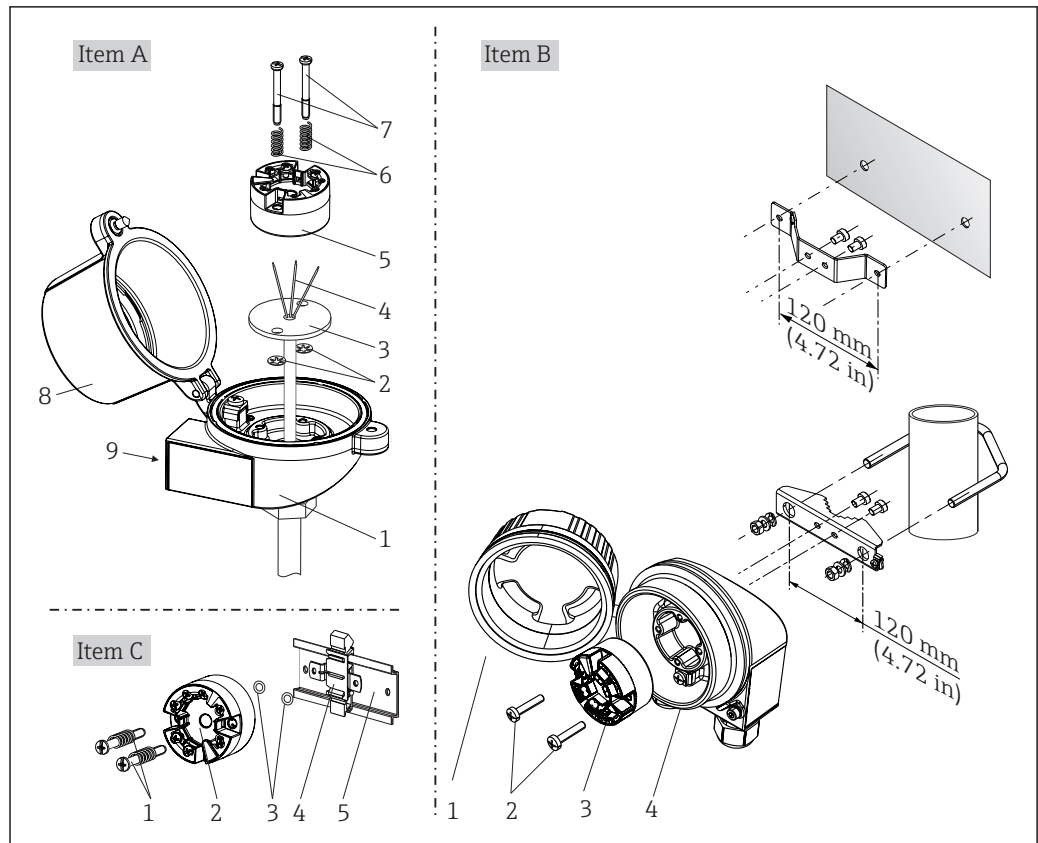

A0014269-EN

3 Head transmitter mounting (three versions)

Item A	Mounting in a terminal head (terminal head flat face as per DIN 43729)
1	Terminal head
2	Circlips
3	Insert
4	Connection wires
5	Head transmitter
6	Mounting springs
7	Mounting screws
8	Terminal head cover
9	Cable entry

Procedure for mounting in a terminal head, pos. A:

1. Open the terminal head cover (8) on the terminal head.
2. Guide the connection wires (4) of the insert (3) through the center hole in the head transmitter (5).
3. Fit the mounting springs (6) on the mounting screws (7).
4. Guide the mounting screws (7) through the side boreholes of the head transmitter and the insert (3). Then fix both mounting screws with the snap rings (2).
5. Then tighten the head transmitter (5) along with the insert (3) in the terminal head.
6. After wiring → 17, close the terminal head cover (8) tightly again.

Item B	Mounting in a field housing
1	Field housing cover
2	Mounting screws with springs
3	Head transmitter
5	Field housing

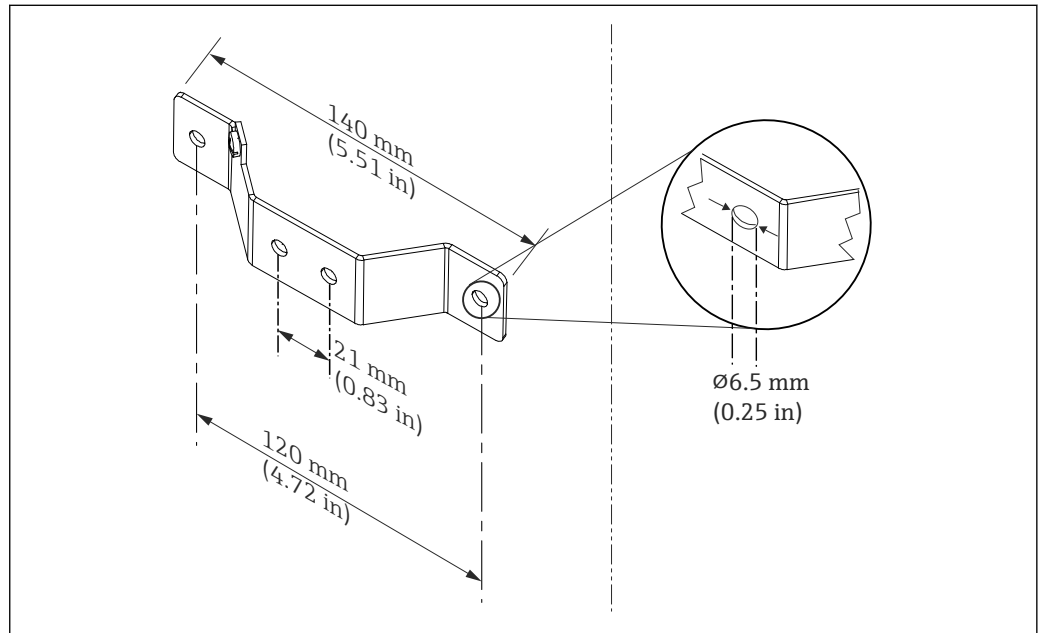

4 Dimensions of angle bracket for wall mount (complete wall mounting set available as accessory)

Procedure for mounting in a field housing, pos. B:

1. Open the cover (1) of the field housing (4).
2. Guide the mounting screws (2) through the lateral bores in the head transmitter (3).
3. Screw the head transmitter to the field housing.
4. After wiring, close the field housing cover (1) → 17 again.

Item C	Mounting on DIN rail (DIN rail as per IEC 60715)
1	Mounting screws with springs
2	Head transmitter
3	Circlips
4	DIN rail clip
5	DIN rail

Procedure for mounting on a DIN rail, pos. C:

1. Press the DIN rail clip (4) onto the DIN rail (5) until it engages with a click.
2. Fit the mounting springs on the mounting screws (1) and guide the screws through the side boreholes of the head transmitter (2). Then fix both mounting screws with the snap rings (3).
3. Screw the head transmitter (2) onto the DIN rail clip (4).

Mounting typical of North America

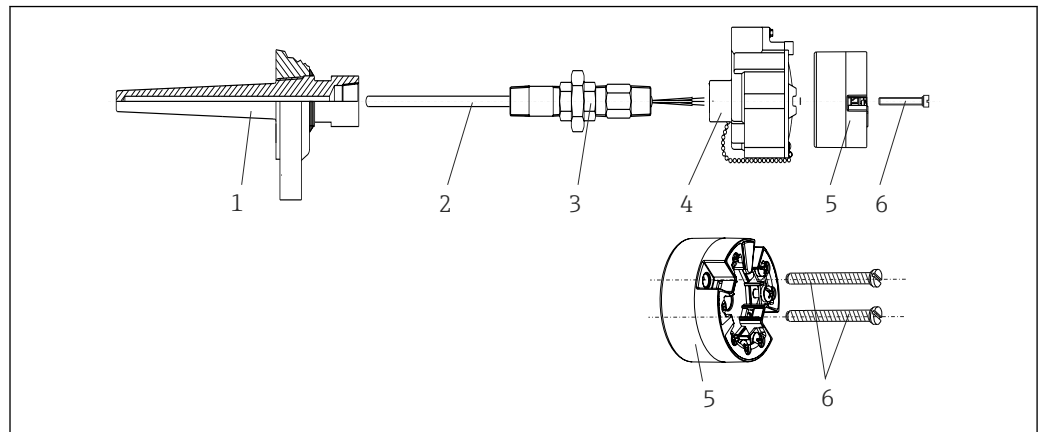

A0008520

5 Head transmitter mounting

- 1 Thermowell
- 2 Insert
- 3 Adapter, coupling
- 4 Terminal head
- 5 Head transmitter
- 6 Mounting screws

Thermometer design with thermocouples or RTD sensors and head transmitter:

1. Fit the thermowell (1) on the process pipe or the container wall. Secure the thermowell according to the instructions before the process pressure is applied.
2. Fit the necessary neck tube nipples and adapter (3) on the thermowell.
3. Make sure sealing rings are installed if such rings are needed for harsh environmental conditions or special regulations.
4. Guide the mounting screws (6) through the lateral bores of the head transmitter (5).
5. Position the head transmitter (5) in the terminal head (4) in such a way that the bus cable (terminals 1 and 2) point to the cable entry.
6. Using a screwdriver, screw down the head transmitter (5) in the terminal head (4).
7. Guide the connection wires of the insert (3) through the lower cable entry of the terminal head (4) and through the middle hole in the head transmitter (5). Wire the connection wires up to the transmitter → 17.
8. Screw the terminal head (4), with the integrated and wired head transmitter, onto the ready-mounted nipple and adapter (3).

NOTICE

The terminal head cover must be secured properly to meet the requirements for explosion protection.

- ▶ After wiring, securely screw the terminal head cover back on.

Mounting the display on the head transmitter

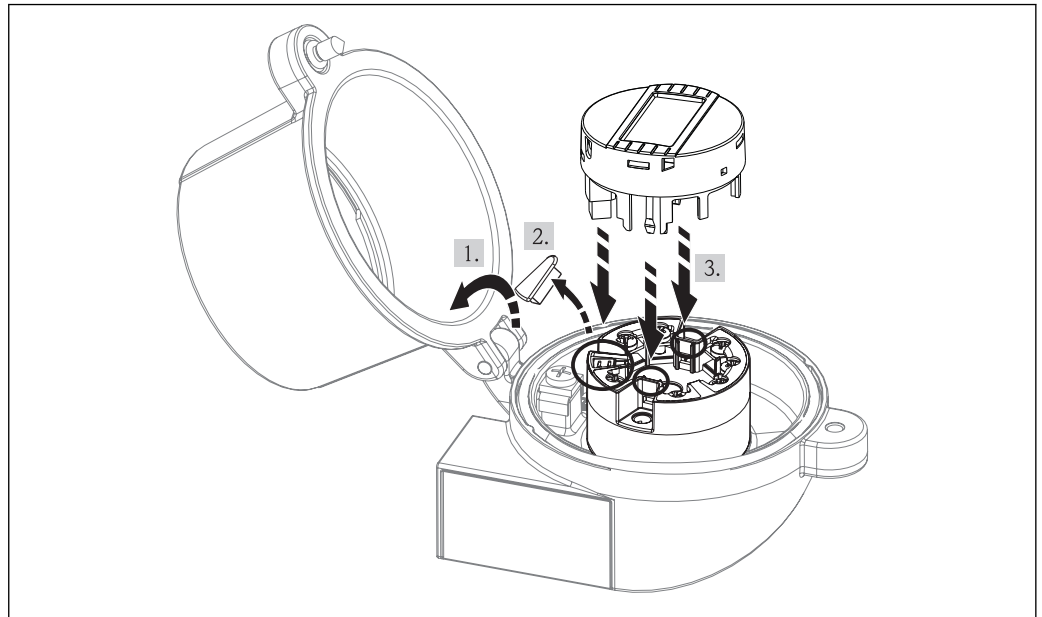

A0009852

6 Mounting the display

1. Loosen the screw on the terminal head cover. Flip back the terminal head cover.
2. Remove the cover of the display connection area.
3. Fit the display module onto the mounted and wired head transmitter. The fastening pins must click securely into place on the head transmitter. After mounting, securely tighten the terminal head cover.

 The display can be used only with the appropriate terminal heads - cover with viewing window (e.g. TA30 from Endress+Hauser).

4.3.2 Mounting the DIN rail transmitter

NOTICE

Wrong orientation

Measurement deviates from the maximum accuracy rating when a thermocouple is connected and the internal reference junction is used.

- ▶ Mount the device vertically and ensure it is oriented correctly (sensor connection at bottom / power supply at top)!

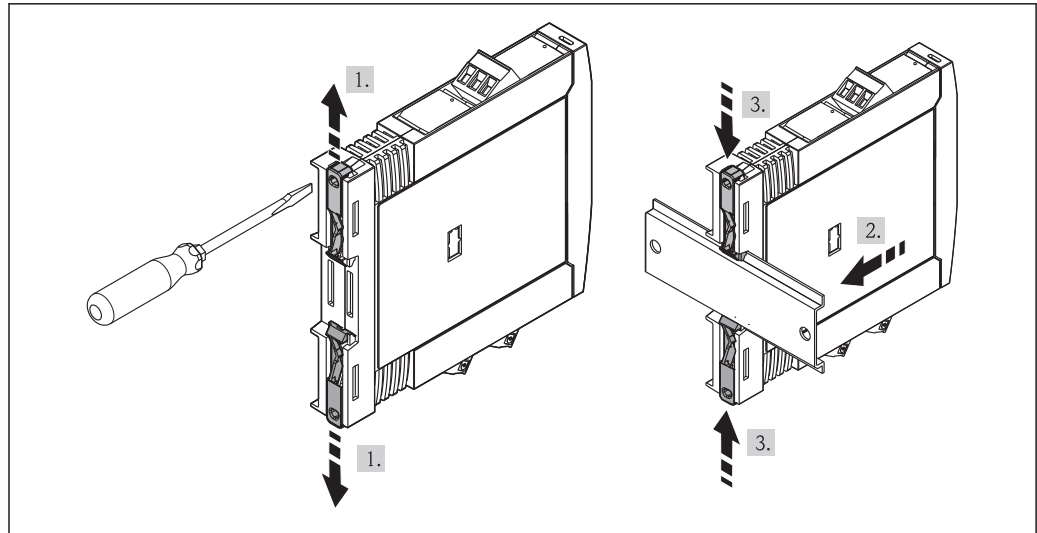

A0017821

 7 *Mounting the DIN rail transmitter*

1. Slide the upper DIN rail clip upwards and the lower clip downwards until they click into place.
2. Fit the device on the DIN rail from the front.
3. Slide the two DIN rail clips back together until they click into place.

4.4 Post-installation check

After installing the device, always run the following final checks:

Device condition and specifications	Notes
Is the device undamaged (visual inspection)?	-
Do the ambient conditions match the device specification (e.g. ambient temperature, measuring range, etc.)?	See 'Technical data' section →  44

5 Wiring

⚠ CAUTION

- ▶ Switch off power supply before installing or connecting the device. Failure to observe this may result in destruction of parts of the electronics.
- ▶ When installing Ex-approved devices in a hazardous area please take special note of the instructions and connection schematics in the respective Ex documentation added to these Operating Instructions. Your supplier is available for assistance if required.
- ▶ Do not occupy the display connection. An incorrect connection can destroy the electronics.



A Phillips head screwdriver is required to wire the head transmitter with screw terminals. A flat-bladed screwdriver must be used for the version with spring terminals and for the DIN rail transmitter.

NOTICE

Do not overtighten the screw terminals, as this could damage the transmitter. Use a suitable screwdriver.

- ▶ Maximum torque for securing screws = 1 Nm ($\frac{3}{4}$ foot-pound), screwdriver: Pozidriv Z2
- ▶ Maximum torque for screw terminals = 0.35 Nm ($\frac{1}{4}$ foot-pound), screwdriver: Pozidriv Z1

For wiring a mounted head transmitter, proceed as follows:

1. Open the cable gland and the housing cover on the terminal head or the field housing.
2. Feed the cables through the opening in the cable gland.
3. Connect the cables in accordance with →  17. If the head transmitter is fitted with spring terminals, pay particular attention to the "Connecting to spring terminals" section →  19.
4. Retighten the cable gland and close the housing cover.

In order to avoid connection errors always take note of the hints given in the section connection check!

5.1 Quick wiring guide

Terminal assignment of head transmitter

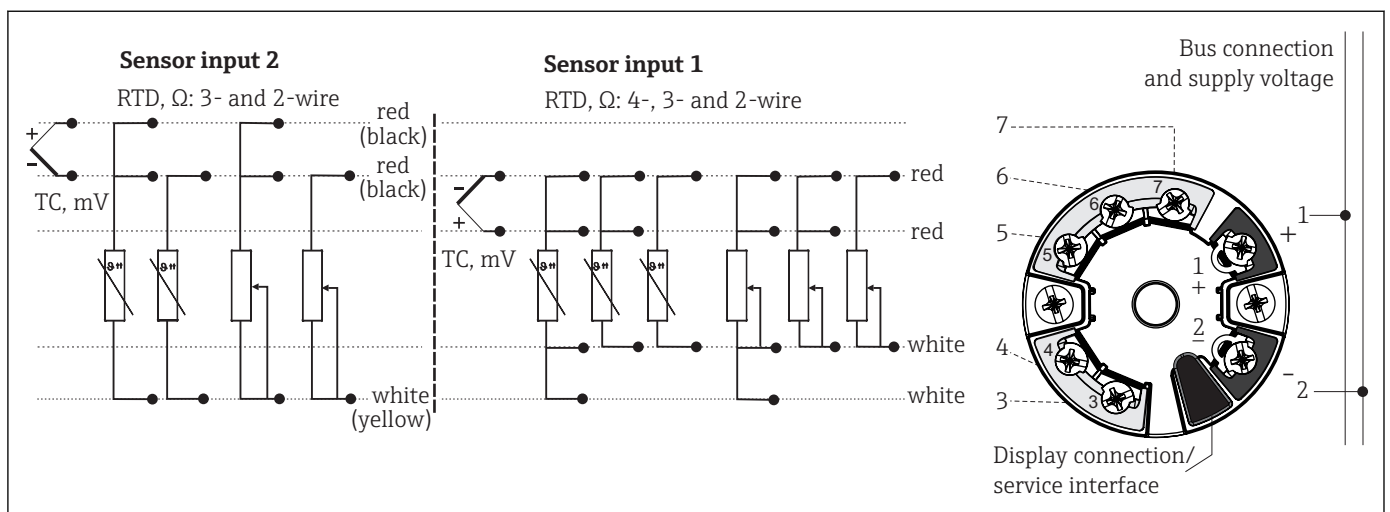

 8 Wiring the head transmitter

Terminal assignment of DIN rail transmitter

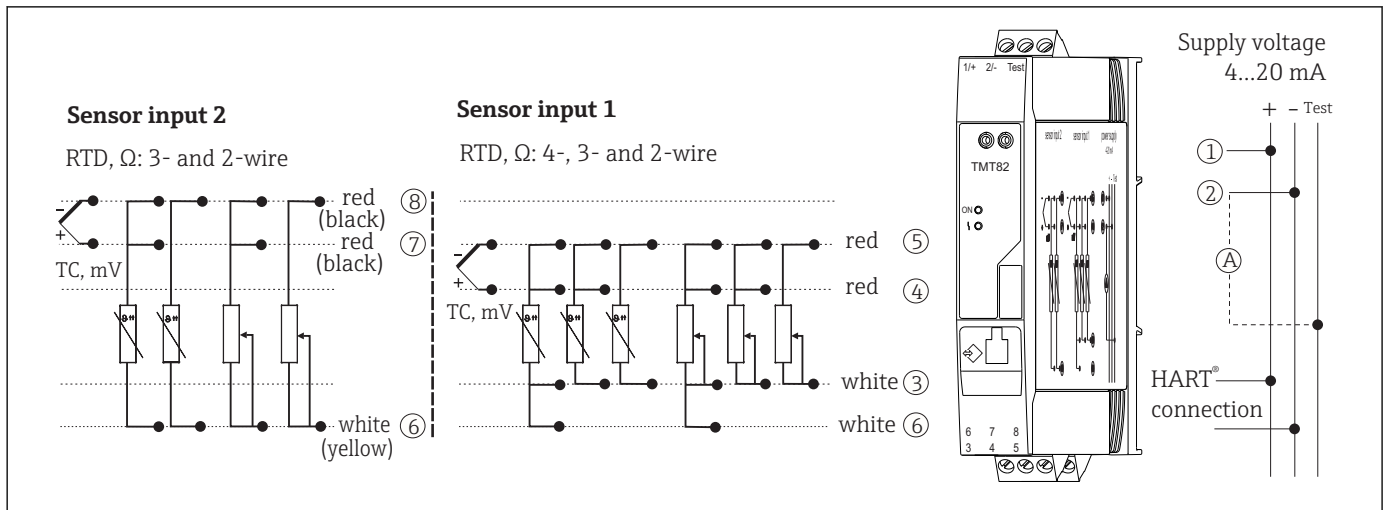

9 Assignment of terminal connections for DIN rail device

A To check the output current, an amperemeter (DC measurement) can be connected between the "Test" and "-" terminals.

To operate the device via the HART® protocol (terminals 1 and 2), a minimum load of 250 Ω is required in the signal circuit.

NOTICE

- ▶ **ESD** - electrostatic discharge. Protect the terminals from electrostatic discharge. Failure to observe this may result in destruction or malfunction of parts of the electronics.

5.2 Connecting the sensor cables

Terminal assignment of the sensor connections → 8, 17.

NOTICE

When connecting 2 sensors ensure that there is no galvanic connection between the sensors (e.g. caused by sensor elements that are not isolated from the thermowell). The resulting equalizing currents distort the measurements considerably.

- ▶ The sensors must remain galvanically isolated from one another by connecting each sensor separately to a transmitter. The transmitter provides sufficient galvanic isolation (> 2 kV AC) between the input and output.

The following connection combinations are possible when both sensor inputs are assigned:

		Sensor input 1			
		RTD or resistance transmitter, 2-wire	RTD or resistance transmitter, 3-wire	RTD or resistance transmitter, 4-wire	Thermocouple (TC), voltage transmitter
Sensor input 2	RTD or resistance transmitter, 2-wire	☑	☑	-	☑
	RTD or resistance transmitter, 3-wire	☑	☑	-	☑
	RTD or resistance transmitter, 4-wire	-	-	-	-
	Thermocouple (TC), voltage transmitter	☑	☑	☑	☑

5.2.1 Connecting to spring terminals

A flat-bladed screwdriver, size 3 mm is required.

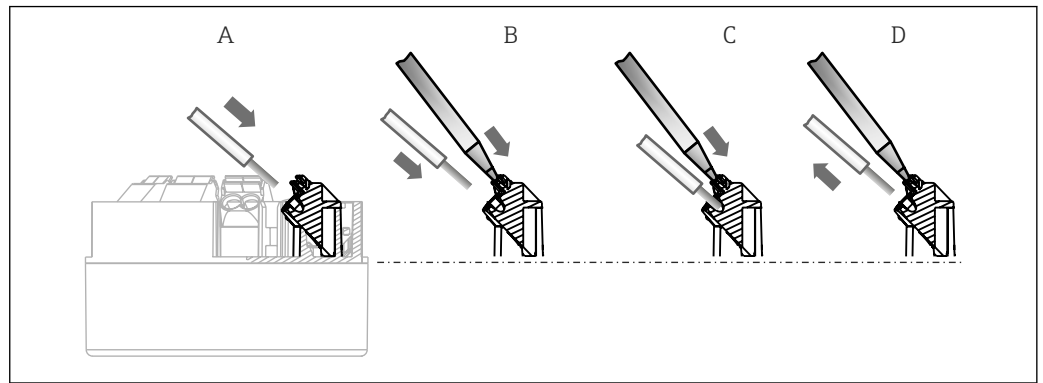

10 Spring terminal connection

Pos. A, solid wire:

1. Strip wire end. Min. stripping length 10 mm (0.39 in).
2. Insert the wire end into the terminal (A).
3. Pull the wire gently to ensure it is connected correctly. Repeat from step 1 if necessary.

Pos. B, fine-strand wire without ferrule:

1. Strip wire end. Min. stripping length 10 mm (0.39 in).
2. Operate lever opener with tool (B).
3. Insert the wire end into the terminal (B).
4. Release lever opener.
5. Pull the wire gently to ensure it is connected correctly. Repeat from step 1 if necessary.

Pos. C and D, releasing the connection:

1. Operate lever opener with tool (C).
2. Remove wire from terminal (D).
3. Release lever opener.

i When connecting flexible cables and spring terminals, it is not recommended to use ferrules.

5.3 Connecting the power supply and signal cables

⚠ CAUTION

- ▶ Switch off power supply before installing or connecting the transmitter. Failure to observe this may result in destruction of parts of the electronics.

i Cable specification

- A normal device cable suffices if only the analog signal is used.
- A shielded cable is recommended for HART® communication. Observe grounding concept of the plant.
- In the case of the DIN rail version, a shielded cable must be used if the sensor cable length exceeds 30 m (98.4 ft). The use of shielded sensor cables is generally recommended.

Please also observe the general procedure on → 17.

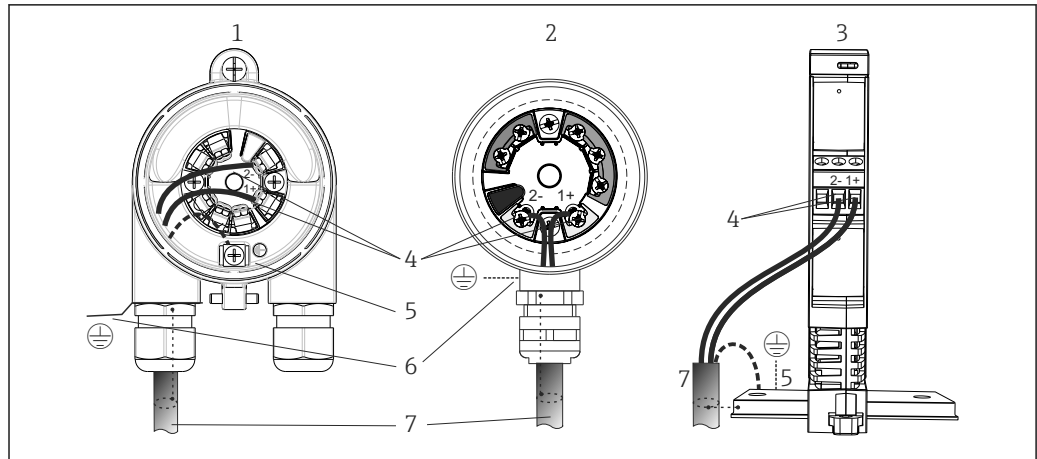

A0017841

11 Connecting the signal cables and power supply

- 1 Head transmitter installed in field housing
- 2 Head transmitter installed in terminal head
- 3 DIN rail transmitter mounted on DIN rail
- 4 Terminals for HART® protocol and power supply
- 5 Internal ground connection
- 6 External ground connection
- 7 Shielded signal cable (recommended for HART® protocol)

- i** The terminals for connecting the signal cable (1+ and 2-) are protected against reverse polarity.
- Conductor cross-section:
 - Max. 2.5 mm² for screw terminals
 - max. 1.5 mm² for spring terminals. Min. stripping length of cable 10 mm (0.39 in).

5.4 Shielding and grounding

The specifications of the HART FieldComm Group must be observed during installation.

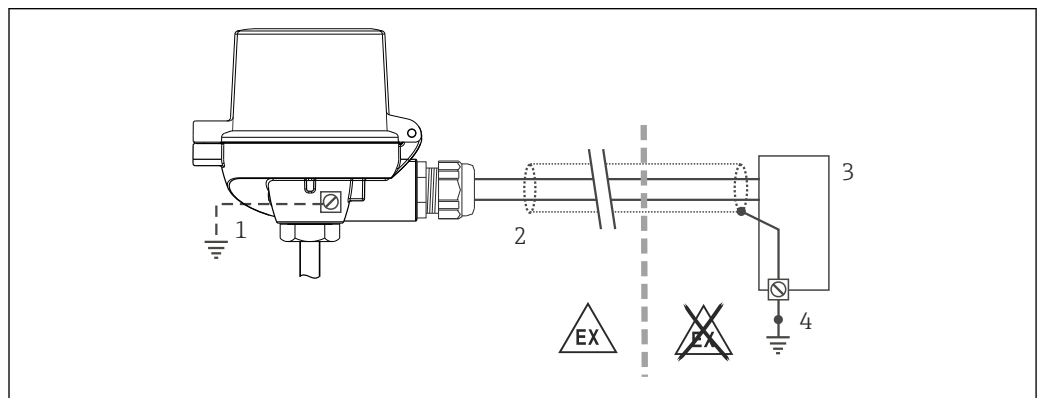

A0014463

12 Shielding and grounding the signal cable at one end with HART® communication

- 1 Optional grounding of the field device, isolated from cable shielding
- 2 Grounding of the cable shield at one end
- 3 Supply unit
- 4 Grounding point for HART® communication cable shield

5.5 Post-connection check

Device condition and specifications	Notes
Is the device or cable undamaged (visual check)?	--
Electrical connection	Notes
Does the supply voltage match the specifications on the nameplate?	<ul style="list-style-type: none"> ▪ Head transmitter: $U = 11$ to $42 V_{DC}$ ▪ DIN rail transmitter: $U = 12$ to $42 V_{DC}$ ▪ SIL mode: $U = 11$ to $32 V_{DC}$ for the head transmitter or $U = 12$ to $32 V_{DC}$ for the DIN rail transmitter
Do the cables have adequate strain relief?	--
Are the power supply and signal cables correctly connected?	→  17
Are all the screw terminals well tightened and have the connections of the spring terminals been checked?	--
Are all the cable entries installed, tightened and sealed?	--
Are all housing covers installed and firmly tightened?	--

6 Operating options

6.1 Overview of operation options

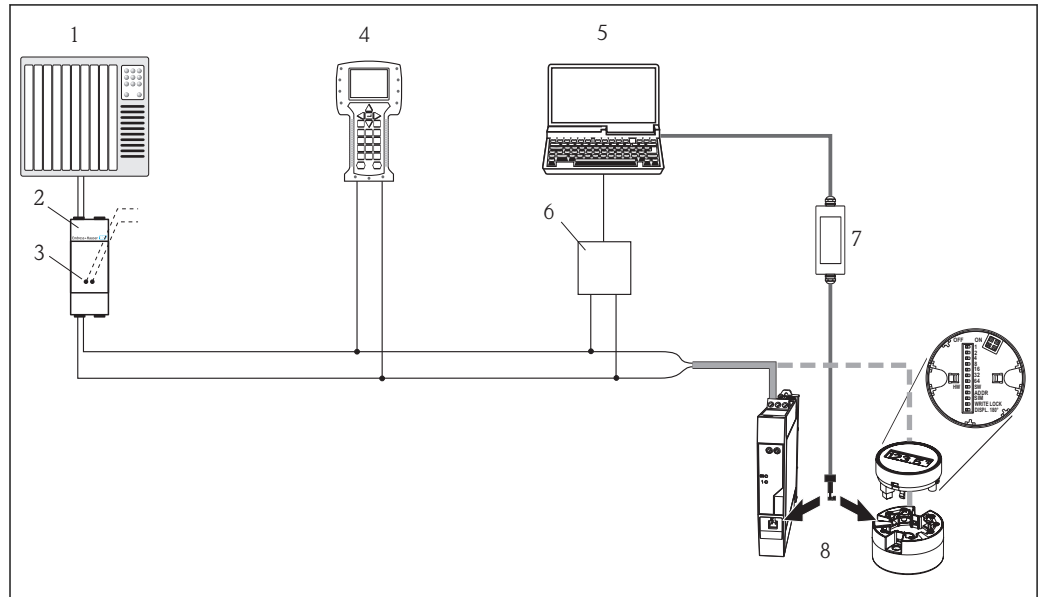

A0014460

 13 Operating options of the temperature transmitter

- 1 PLC (programmable logic control)
- 2 Transmitter power supply unit, e.g. RN221N (with communication resistor)
- 3 Connection for HART[®] modem Commubox FXA191, FXA195
- 4 Field Communicator 375, 475
- 5 Computer with operating tool (e.g. FieldCare, AMS Device Manager, SIMATIC PDM)
- 6 HART[®] modem Commubox FXA191 (RS232) or FXA195 (USB)
- 7 Commubox FXA291 (USB) or TXU10 (USB) for connecting to the CDI interface
- 8 Temperature transmitter as head transmitter or DIN rail device, onsite operation via DIP switches on rear of optional display possible only for head transmitter

 For the head transmitter, display and operating elements are available locally only if the head transmitter was ordered with a display unit!

6.2 Structure and function of the operating menu

6.2.1 Structure of the operating menu

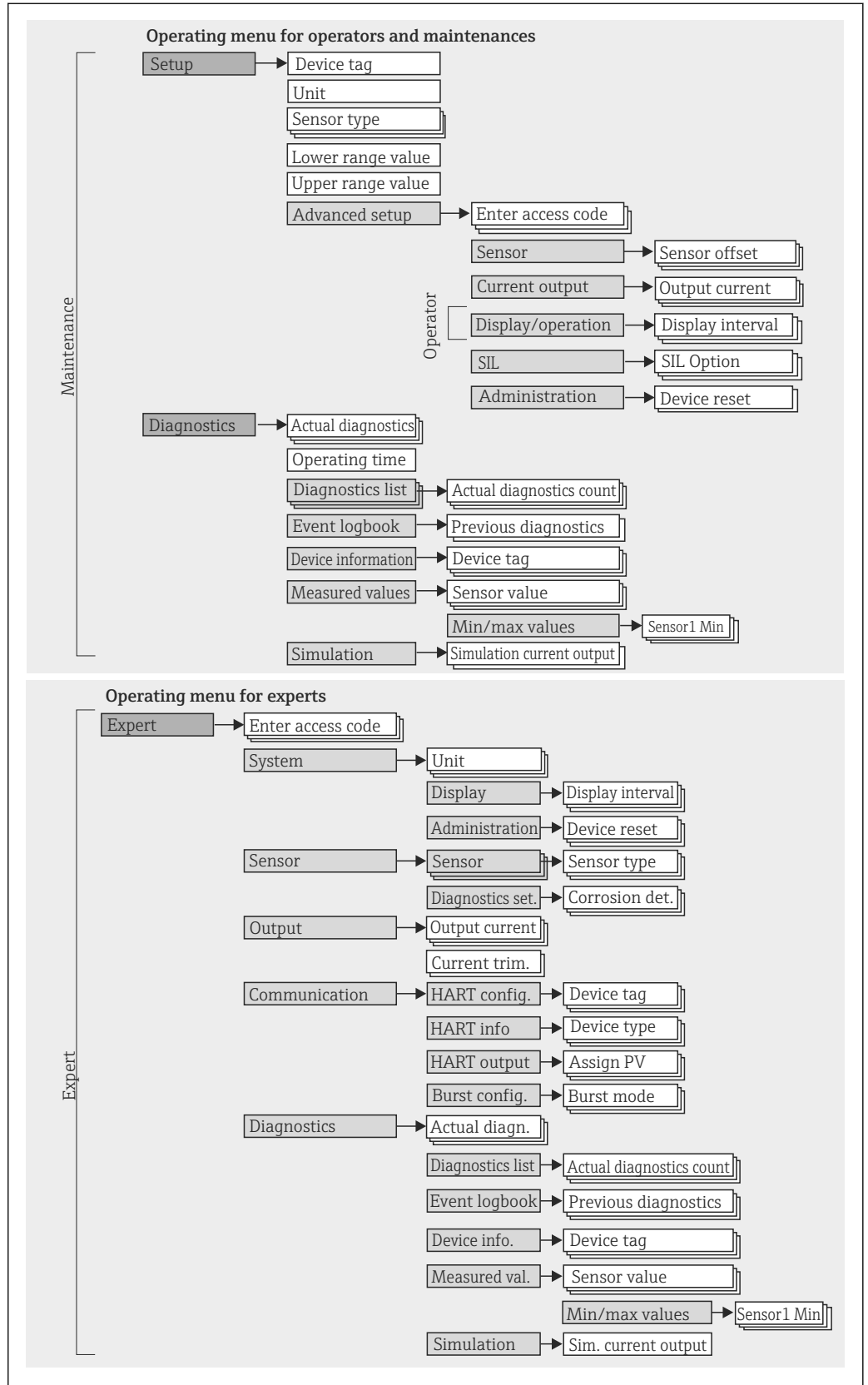

A0014757-EN



Configuration in the SIL mode differs from the standard mode and is described in the Functional Safety Manual. For more information please refer to the Functional Safety Manual SD01172T/09.

Submenus and user roles

Certain parts of the menu are assigned to certain user roles. Each user role corresponds to typical tasks within the lifecycle of the device.

User role	Typical tasks	Menu	Content/meaning
Maintenance Operator	<p>Commissioning:</p> <ul style="list-style-type: none"> ▪ Configuration of the measurement. ▪ Configuration of data processing (scaling, linearization, etc.). ▪ Configuration of the analog measured value output. <p>Tasks during operation:</p> <ul style="list-style-type: none"> ▪ Configuration of the display. ▪ Reading measured values. 	"Setup"	<p>Contains all parameters for commissioning:</p> <ul style="list-style-type: none"> ▪ Setup parameters Once values have been set for these parameters, the measurement should generally be completely configured. ▪ "Extended Setup" submenu Contains additional submenus and parameters: <ul style="list-style-type: none"> - For more accurate configuration of the measurement (adaptation to special measuring conditions). - For converting the measured value (scaling, linearization). - For scaling the output signal. - Required in ongoing operation: configuration of the measured value display (displayed values, display format, etc.).
	<p>Fault elimination:</p> <ul style="list-style-type: none"> ▪ Diagnosing and eliminating process errors. ▪ Interpretation of device error messages and correcting associated errors. 	"Diagnostics"	<p>Contains all parameters for detecting and analyzing errors:</p> <ul style="list-style-type: none"> ▪ Diagnostic list Contains up to 3 currently pending error messages. ▪ Event logbook Contains the last 5 error messages (no longer pending). ▪ "Device information" submenu Contains information for identifying the device. ▪ "Measured values" submenu Contains all current measured values. ▪ "Simulation" submenu Is used to simulate measured values or output values. ▪ "Device reset" submenu
Expert	<p>Tasks that require detailed knowledge of the function of the device:</p> <ul style="list-style-type: none"> ▪ Commissioning measurements under difficult conditions. ▪ Optimal adaptation of the measurement to difficult conditions. ▪ Detailed configuration of the communication interface. ▪ Error diagnostics in difficult cases. 	"Expert"	<p>Contains all parameters of the device (including those that are already in one of the other menus). The structure of this menu is based on the function blocks of the device:</p> <ul style="list-style-type: none"> ▪ "System" submenu Contains all higher-order device parameters that do not pertain either to measurement or the measured value communication. ▪ "Sensor" submenu Contains all parameters for configuring the measurement. ▪ "Output" submenu Contains all parameters for configuring the analog current output. ▪ "Communication" submenu Contains all parameters for configuring the digital communication interface. ▪ "Diagnostics" submenu Contains all parameters for detecting and analyzing errors.

6.3 Measured value display and operating elements

6.3.1 Display elements

Head transmitter

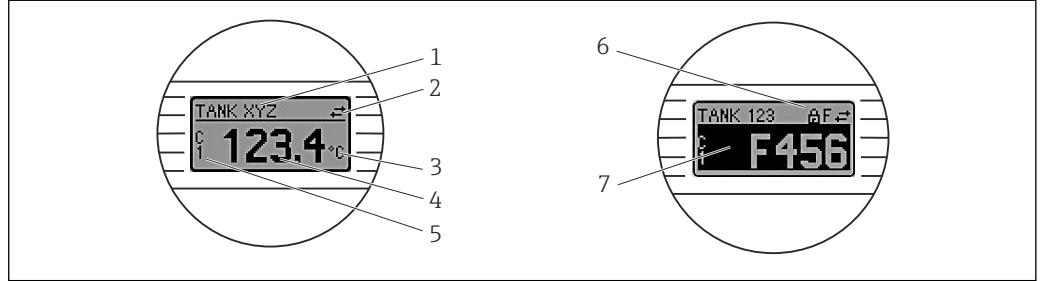

A0008549

14 Optional LC display for head transmitter

Item No.	Function	Description
1	Displays the TAG	TAG, 32 characters long.
2	'Communication' symbol	The communication symbol appears when read and write-accessing via the fieldbus protocol.
3	Unit display	Unit display for the measured value displayed.
4	Measured value display	Displays the current measured value.
5	Value/channel display S1, S2, DT, PV, I, %	e.g. S1 for a measured value from channel 1 or DT for the device temperature
6	'Configuration locked' symbol	The 'configuration locked' symbol appears when configuration is locked via the hardware.
7	Status signals	
	Symbols	Meaning
	F	Error message "Failure detected" An operating error has occurred. The measured value is no longer valid. The display alternates between the error message and "- - -" (no valid measured value present), see "Diagnostics events" → 39 section.
	C	"Service mode" The device is in service mode (e.g. during a simulation).
	S	"Out of specification" The device is being operated outside its technical specifications (e.g. during warm-up or cleaning processes).
	M	"Maintenance required" Maintenance is required. The measured value is still valid. The display alternates between the measured value and the status message.

DIN rail transmitter

i The DIN rail transmitter version does not have an interface to the LC display and therefore does not have a local display either.

Two LEDs on the front indicate the device status in accordance with NAMUR NE44.

Type	Function and characteristic
Status LED (red)	<p>When the device is operating without errors, the device status is displayed. This function can no longer be guaranteed in the event of an error.</p> <ul style="list-style-type: none"> LED off: without diagnostic message LED is lit: diagnostics display, category F LED flashing: diagnostics display of categories C, S or M
Power LED (green) 'ON'	<p>When the device is operating without errors, the operating status is displayed. This function can no longer be guaranteed in the event of an error.</p> <ul style="list-style-type: none"> LED off: Power failure or insufficient supply voltage LED is lit: Supply voltage is OK (either via CDI or via supply voltage, terminals 1+, 2-)

6.3.2 Local operation

You can make hardware settings for the fieldbus interface using miniature switches (DIP switches) on the rear of the optional display.

i The user has the option of ordering the display with the head transmitter, or as an accessory for subsequent mounting. → 34

NOTICE

▶ ESD - electrostatic discharge. Protect the terminals from electrostatic discharge. Failure to observe this may result in destruction or malfunction of parts of the electronics.

	1: Connection to head transmitter
	2: DIP switch (1 - 64, SW/HW, ADDR and SIM = simulation mode) no function for this head transmitter
	3: DIP switch (WRITE LOCK = write protection; DISPL. 180° = switch, turn the display monitor 180°)

15 Hardware settings via DIP switches

Procedure for setting the DIP switch:

1. Open the cover of the terminal head or field housing.
2. Remove the attached display from the head transmitter.
3. Configure the DIP switch on the rear of the display accordingly. In general: switch to ON = function enabled, switch to OFF = function disabled.
4. Fit the display onto the head transmitter in the correct position. The head transmitter accepts the settings within one second.
5. Secure the cover back onto the terminal head or field housing.

Switching write protection on/off

Write protection is switched on and off via a DIP switch on the rear of the optional attachable display. When write protection is active, parameters cannot be modified. A key symbol on the display indicates that the write protection is on. Write protection prevents any write access to the parameters. The write protection remains active even when the

display is removed. To deactivate the write protection, the device must be restarted with the display attached and the DIP switch deactivated (WRITE LOCK = OFF).

Turning the display

The display can be rotated 180° using the "DISPL. 180°" DIP switch. The setting is retained when the display is removed.

6.4 Access to the operating menu via the operating tool

6.4.1 FieldCare

Function scope

FDT/DTM-based plant asset management tool from Endress+Hauser. It can configure all smart field units in a system and help you manage them. By using the status information, it is also a simple but effective way of checking their status and condition. Access takes place via the HART® protocol or CDI (= Endress+Hauser Common Data Interface).

Typical functions:

- Configuring parameters of transmitters
- Loading and saving device data (upload/download)
- Documentation of the measuring point
- Visualization of the measured value memory (line recorder) and event logbook



For details, see Operating Instructions BA027S/04/xx and BA059AS/04/xx

NOTICE

For use in hazardous areas: Before accessing the device with the Commubox FXA291 via the CDI (= Endress+Hauser Common Data Interface), disconnect the transmitter from the power supply, terminals (1+) and (2-).

- ▶ Failure to comply with this instruction can result in damage to parts of the electronics.

Source for device description files

See data →  30

User interface

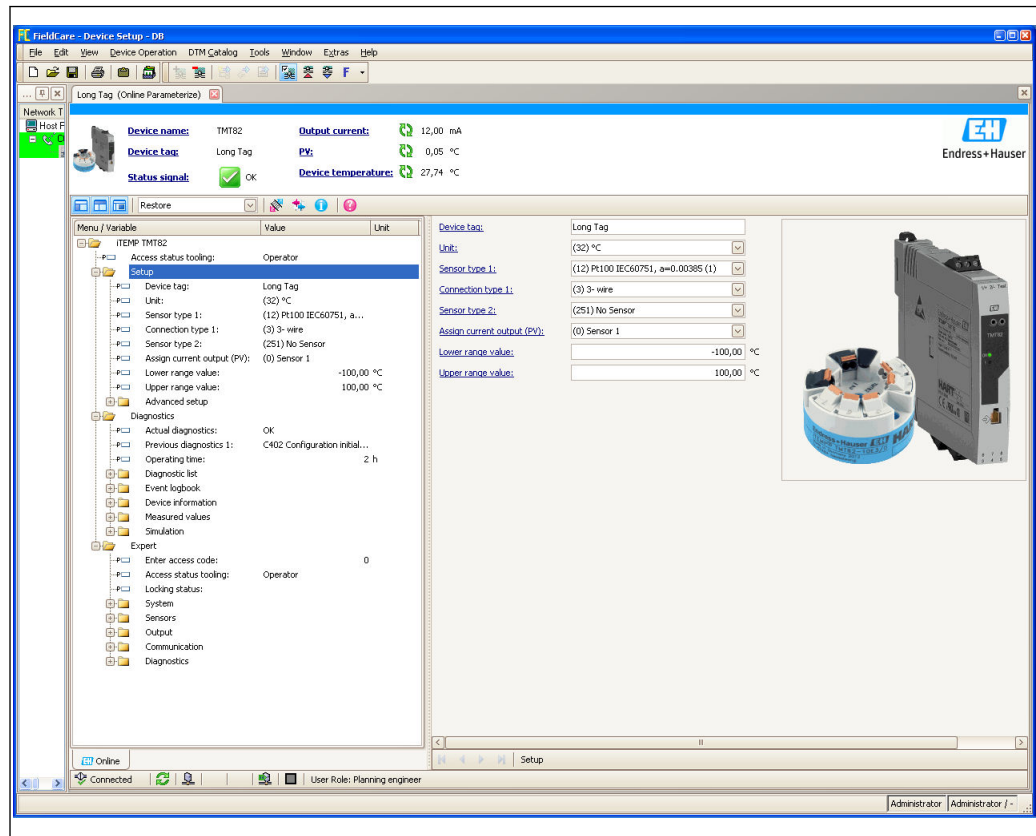

A0014485-EN

6.4.2 Field Xpert

Function scope

Field Xpert is an industrial PDA with integrated touchscreen for commissioning and maintaining field devices in explosion hazardous and safe areas. It allows efficient configuration of FOUNDATION fieldbus, HART and WirelessHART devices via Bluetooth and/or Wifi interfaces.

6.4.3 Source for device description files

See data → 30

6.4.4 AMS Device Manager

Function scope

Program from Emerson Process Management for operating and configuring measuring devices via the HART® protocol.

Source for device description files

See data → 30

6.4.5 SIMATIC PDM

Function scope

SIMATIC PDM is a standardized, manufacturer-independent program from Siemens for the operation, configuration, maintenance and diagnosis of intelligent field devices via the HART[®] protocol.

Source for device description files

See data →  30

6.4.6 Field Communicator 375/475

Function scope

Industrial handheld terminal from Emerson Process Management for remote configuration and measured value display via the HART[®] protocol.

Source for device description files

See data →  30





7 Integrating the transmitter via the HART® protocol

 For secure HART® communication in accordance with functional safety as defined in IEC 61508 (SIL mode), measured values are sent securely from the transmitter via the HART® protocol to a connected control system where they are processed further in a secure manner. Secure HART® communication works using special HART® commands that are only available in the SIL mode.

The secure HART® protocol includes technologies, that are licenced by Rockwell Automation.

 For more information please refer to the Functional Safety Manual SD01172T/09.

Version data for the device

Firmware version	01.01.zz	<ul style="list-style-type: none"> ▪ On the title page of the Operating instructions ▪ On nameplate → ,  ▪ Parameter firmware version Diagnostics → Device info → Firmware version
Manufacturer ID	0x11	Manufacturer ID parameter Diagnostics → Device info → Manufacturer ID
Device type ID	11CC	Device type parameter Diagnostics → Device info → Device type
HART protocol revision	7.0	---
Device revision	2	<ul style="list-style-type: none"> ▪ On transmitter nameplate → ,  ▪ Device revision parameter Diagnostics → Device info → Device revision

The suitable device description file (DD) for the individual operating tools is listed in the table below, along with information on where the file can be acquired.

Operating tools

Operating tool	Sources for obtaining device descriptions (DD)
FieldCare	<ul style="list-style-type: none"> ▪ www.endress.com → Download Area ▪ CD-ROM (contact Endress+Hauser) ▪ DVD (contact Endress+Hauser)
AMS Device Manager (Emerson Process Management)	www.endress.com → Download Area
SIMATIC PDM (Siemens)	www.endress.com → Download Area
Field Communicator 375, 475 (Emerson Process Management)	Use update function of handheld terminal
FieldXpert SFX350, SFX370 (Endress+Hauser)	Use update function of handheld terminal

7.1 HART device variables and measured values

The following measured values are assigned to the device variables at the factory:

Device variables for temperature measurement

Device variable	Measured value
Primary device variable (PV)	Sensor 1
Secondary device variable (SV)	Device temperature

Device variable	Measured value
Tertiary device variable (TV)	Sensor 1
Quaternary device variable (QV)	Sensor 1

 It is possible to change the assignment of device variables to process variables in the **Expert → Communication → HART output** menu.

7.2 Device variables and measured values

The following measured values are assigned to the individual device variables:

Device variable code	Measured value
0	Sensor 1
1	Sensor 2
2	Device temperature
3	Average of sensor 1 and sensor 2
4	Difference between sensor 1 and sensor 2
5	Sensor 1 (backup sensor 2)
6	Sensor 1 with switchover to sensor 2 if a limit value is exceeded
7	Average of sensor 1 and sensor 2 with backup

 The device variables can be queried from a HART® master using HART® command 9 or 33.

7.3 Supported HART® commands

 The HART® protocol enables the transfer of measuring data and device data between the HART® master and the field device for configuration and diagnostics purposes. HART® masters such as the handheld terminal or PC-based operating programs (e.g. FieldCare) need device description files (DD, DTM) which are used to access all the information in a HART® device. This information is transmitted exclusively via "commands".

There are three different types of command

- **Universal commands:**
All HART® devices support and use universal commands. These are associated with the following functionalities for example:
 - Recognition of HART® devices
 - Reading digital measured values
- **Common practice commands:**
Common practice commands offer functions which are supported and can be executed by many but not all field devices.
- **Device-specific commands:**
These commands allow access to device-specific functions which are not HART® standard. Such commands access individual field device information, among other things.

Command No.	Designation
Universal commands	
0, Cmd0	Read unique identifier
1, Cmd001	Read primary variable

Command No.	Designation
2, Cmd002	Read loop current and percent of range
3, Cmd003	Read dynamic variables and loop current
6, Cmd006	Write polling address
7, Cmd007	Read loop configuration
8, Cmd008	Read dynamic variable classifications
9, Cmd009	Read device variables with status
11, Cmd011	Read unique identifier associated with TAG
12, Cmd012	Read message
13, Cmd013	Read TAG, descriptor, date
14, Cmd014	Read primary variable transducer information
15, Cmd015	Read device information
16, Cmd016	Read final assembly number
17, Cmd017	Write message
18, Cmd018	Write TAG, descriptor, date
19, Cmd019	Write final assembly number
20, Cmd020	Read long TAG (32-byte TAG)
21, Cmd021	Read unique identifier associated with long TAG
22, Cmd022	Write long TAG (32-byte TAG)
38, Cmd038	Reset configuration changed flag
48, Cmd048	Read additional device status
Common practice commands	
33, Cmd033	Read device variables
34, Cmd034	Write primary variable damping value
35, Cmd035	Write primary variable range values
36, Cmd036	Set primary variable upper range value
37, Cmd037	Set primary variable lower range value
40, Cmd040	Enter/Exit fixed current mode
42, Cmd042	Perform device reset
44, Cmd044	Write primary variable units
45, Cmd045	Trim loop current zero
46, Cmd046	Trim loop current gain
50, Cmd050	Read dynamic variable assignments
51, Cmd051	Write dynamic variable assignments
54, Cmd054	Read device variable information
59, Cmd059	Write number of response preambles
103, Cmd103	Write burst period
104, Cmd104	Write burst trigger
105, Cmd105	Read burst mode configuration
107, Cmd107	Write burst device variables
108, Cmd108	Write burst mode command number
109, Cmd109	Burst mode control

8 Commissioning



8.1 Post-installation check

Before commissioning the measuring point make sure that all final checks have been carried out:

- Checklist "Post-installation check", →  16
- Checklist "Post-connection check",

8.2 Switching on the transmitter

Once the final checks have been successfully completed, it is time to switch on the supply voltage. The transmitter performs a number of internal test functions after power-up. As this procedure progresses, the following sequence of messages appears on the display:



Step	Display
1	"Display" text and firmware version of the display
2	Firm logo
3	Device name with firmware and hardware versions
4	Information on the sensor configuration (sensor element and type of connection)
5	Set measuring range
6a	Current measured value or
6b	Current status message  If the switch-on procedure is not successful, the relevant diagnostics event, depending on the cause, is displayed. A detailed list of diagnostic events and the corresponding troubleshooting instructions can be found in the "Diagnostics and troubleshooting" section →  37.

The device is operational after approx. 30 seconds, and the plug-in display after approx. 33 seconds in normal operating mode! Normal measuring mode commences as soon as the switch-on procedure is completed. Measured values and status values appear on the display.

8.3 Enabling configuration

If the device is locked and the parameter settings cannot be changed, it must first be enabled via the hardware or software lock. The device is write-protected if the keyhole symbol appears in the header of the measured value display.

To unlock the device

- either switch the write protection switch on the back of the display to the "OFF" position (hardware write protection), →  26 or
- deactivate the software write protection via the operating tool. See the description for the '**Define device write protection**' parameter. →  84

 When hardware write protection is active (write protection switch on the back of the display to the "ON" position), write protection cannot be disabled via the operating tool. Hardware write protection must always be disabled before software write protection can be enabled or disabled.

9 Maintenance

In general, no specific maintenance is required for this device.

10 Accessories

Various accessories, which can be ordered with the device or subsequently from Endress+Hauser, are available for the device. Detailed information on the order code in question is available from your local Endress+Hauser sales center or on the product page of the Endress+Hauser website: www.endress.com.





Accessories included in the scope of delivery:

- Multilingual Brief Operating Instructions as hard copy
- Optional Functional Safety Manual (SIL mode) as hard copy
- ATEX supplementary documentation: ATEX Safety instructions (XA), Control Drawings (CD)
- Mounting material for head transmitter

10.1 Device-specific accessories

Accessories
Display unit TID10 for Endress+Hauser head transmitter iTEMP TMT8x, attachable
TID10 service cable; connecting cable for service interface, 40 cm
Field housing TA30x for Endress+Hauser head transmitter
Adapter for DIN rail mounting, clip as per IEC 60715 (TH35) without securing screws
Standard - DIN mounting set (2 screws + springs, 4 securing disks and 1 display connector cover)
US - M4 Mounting screws (2 M4 screws and 1 display connector cover)
Stainless steel wall mounting bracket Stainless steel pipe mounting bracket



10.2 Communication-specific accessories





Accessories	Description
Commubox FXA195 HART	For intrinsically safe HART® communication with FieldCare via the USB interface.  For details, see Technical Information TI404F/00
Commubox FXA291	Connects Endress+Hauser field devices with a CDI interface (= Endress+Hauser Common Data Interface) and the USB port of a computer or laptop.  For details, see Technical Information TI405C/07
WirelessHART adapter	Is used for the wireless connection of field devices. The WirelessHART® adapter can be easily integrated into field devices and existing infrastructures, offers data protection and transmission safety and can be operated in parallel with other wireless networks.  For details, see Operating Instructions BA061S/04
Fieldgate FXA320	Gateway for accessing connected 4-20 mA measuring devices via a web browser.  For details, see Technical Information TI025S/04
Fieldgate FXA520	Gateway for accessing connected HART® measuring devices via a web browser.  For details, see Technical Information TI025S/04

10.3 Service-specific accessories

Accessories	Description
Applicator	<p>Software for selecting and sizing Endress+Hauser measuring devices:</p> <ul style="list-style-type: none"> Calculation of all the necessary data for identifying the optimum measuring device: e.g. pressure loss, accuracy or process connections. Graphic illustration of the calculation results <p>Administration, documentation and access to all project-related data and parameters over the entire life cycle of a project.</p> <p>Applicator is available:</p> <ul style="list-style-type: none"> Via the Internet: https://wapps.endress.com/applicator On CD-ROM for local PC installation.
Konfigurator ^{+temperature}	<p>Software for selecting and configuring the product depending on the measuring task, supported by graphics. Includes a comprehensive knowledge database and calculation tools:</p> <ul style="list-style-type: none"> For temperature competence Quick and easy design and sizing of temperature measuring points Ideal measuring point design and sizing to suit the processes and needs of a wide range of industries <p>The Konfigurator is available: On request from your Endress+Hauser sales office on a CD-ROM for local PC installation.</p>
W@M	<p>Life cycle management for your plant W@M supports you with a wide range of software applications over the entire process: from planning and procurement, to the installation, commissioning and operation of the measuring devices. All the relevant device information, such as the device status, spare parts and device-specific documentation, is available for every device over the entire life cycle.</p> <p>The application already contains the data of your Endress+Hauser device. Endress+Hauser also takes care of maintaining and updating the data records.</p> <p>W@M is available:</p> <ul style="list-style-type: none"> Via the Internet: www.endress.com/lifecyclemanagement On CD-ROM for local PC installation.
FieldCare	<p>FDT-based plant asset management tool from Endress+Hauser. It can configure all smart field units in your system and helps you manage them. By using the status information, it is also a simple but effective way of checking their status and condition.</p> <p> For details, see Operating Instructions BA00027S and BA00059S</p>

10.4 System components

Accessories	Description
Advanced Data Manager Memograph M	<p>The Advanced Data Manager Memograph M is a flexible and powerful system for organizing process values. The measured process values are clearly presented on the display and logged safely, monitored against limit values, and analyzed. Via common communication protocols, the measured and calculated values can be easily communicated to higher-level systems and individual plant modules can be interconnected.</p> <p> For details, see Technical Information TI01180R/09</p>
Universal Data Manager Ecograph T	<p>Multi-channel data recording system with LC color graphic display (120 mm / 4.7" screen size), galvanically isolated universal inputs (U, I, TC, RTD), digital input, transmitter power supply, limit relay, communication interfaces (USB, Ethernet, RS232/485), Internal flash memory and compact flash card.</p> <p> For details, see Technical Information TI01079R/09</p>

Accessories	Description
RN221N	<p>Active barrier with power supply for safe separation of 4 to 20 mA standard signal circuits. Has bidirectional HART® transmission and optional HART® diagnosis if transmitters are connected with monitoring of 4 to 20 mA signal or HART® status byte analysis and an E+H-specific diagnostic command.</p> <p> For details, see Technical Information TI073R/09</p>
RNS221	<p>Supply unit for powering two 2-wire measuring devices solely in the non-Ex area. Bidirectional communication is possible via the HART® communication jacks.</p> <p> For details, see Technical Information TI081R/09</p>
RB223	<p>One- or two-channel, loop-powered barrier for safe separation of 4 to 20 mA standard signal circuits. Bidirectional communication is possible via the HART communication jacks.</p> <p> For details, see Technical Information TI132R/09</p>
RIA14, RIA16	<p>Loop-powered field indicator for 4 to 20 mA circuit, RIA14 in flameproof metal enclosure</p> <p> For details, see Technical Information TI143R/09 and TI144R/09</p>
RIA15	<p>Process display, digital loop-powered display for 4 to 20 mA circuit, panel mounting, with optional HART® communication. Displays 4 to 20 mA or up to 4 HART® process variables</p> <p> For details, see Technical Information TI01043K/09</p>

11 Diagnostics and troubleshooting

11.1 Troubleshooting

Always start troubleshooting with the checklists below if faults occur after start up or during operation. This takes you directly (via various queries) to the cause of the problem and the appropriate remedial measures.

 Due to its design, the device cannot be repaired. However, it is possible to send the device in for examination. See the information in the "Return" section. →  43

General errors

Problem	Possible cause	Remedy
Device is not responding.	Supply voltage does not match that specified on the nameplate.	Apply correct voltage.
	Connecting cables are not in contact with the terminals.	Check the contacting of the cables and correct if necessary.
Output current < 3.6 mA	Signal line is not wired correctly.	Check wiring.
	Electronics unit is defective.	Replace the device.
HART communication is not working.	Missing or incorrectly installed communication resistor.	Install the communication resistor (250 Ω) correctly.
	Commubox is not properly connected.	Connect Commubox correctly .
	Commubox is not set to "HART".	Set Commubox selector switch to "HART".
Status LED is lit or flashing red (DIN rail transmitter only).	Diagnostics events as per NAMUR NE107 →  39	Check diagnostics events: <ul style="list-style-type: none"> ■ LED is lit: diagnostic display, category F ■ LED flashing: diagnostic display of categories C, S or M
Power LED is not lit green (DIN rail transmitter only).	Power failure or insufficient supply voltage	Check the supply voltage and check if wiring is correct.

Check display (optional in conjunction with head transmitter)

Problem	Possible cause	Remedy
No display visible	No supply voltage	<ul style="list-style-type: none"> ■ Check the supply voltage at the head transmitter, terminals + and -. ■ Ensure that the display module holders are correctly seated and that the display module is properly connected to the head transmitter. ■ If possible, test the display module with other suitable head transmitters e.g. Endress+Hauser head transmitter.
	The display module is defective.	Replace the module.
	The electronics of the head transmitter are defective.	Replace the head transmitter.

Application errors without status messages for RTD sensor connection

Problem	Possible cause	Remedy
Measured value is incorrect/ inaccurate	Incorrect sensor orientation.	Install the sensor correctly.
	Heat conducted by sensor.	Observe the face-to-face length of the sensor.
	Device programming is incorrect (number of wires).	Change the Connection type device function.
	Device programming is incorrect (scaling).	Change scaling.
	Incorrect RTD configured.	Change the Sensor type device function.
	Sensor connection.	Check that the sensor is connected correctly.
	The cable resistance of the sensor (two-wire) was not compensated.	Compensate the cable resistance.
	Offset incorrectly set.	Check offset.
Failure current (≤ 3.6 mA or ≥ 21 mA)	Faulty sensor.	Check the sensor.
	RTD connected incorrectly.	Connect the connecting cables correctly (terminal diagram).
	Incorrect device programming (e.g. number of wires).	Change the Connection type device function.
	Incorrect programming.	Incorrect sensor type set in the Sensor type device function. Set the correct sensor type.

Application errors without status messages for TC sensor connection

Problem	Possible cause	Remedy
Measured value is incorrect/ inaccurate	Incorrect sensor orientation.	Install the sensor correctly.
	Heat conducted by sensor.	Observe the face-to-face length of the sensor.
	Device programming is incorrect (scaling).	Change scaling.
	Incorrect thermocouple type (TC) configured.	Change the Sensor type device function.
	Incorrect comparison measuring point set.	Set the correct comparison measuring point. →  67
	Interference via the thermocouple wire welded in the thermowell (interference voltage coupling).	Use a sensor where the thermocouple wire is not welded.
	Offset incorrectly set.	Check offset.
Failure current (≤ 3.6 mA or ≥ 21 mA)	Faulty sensor.	Check the sensor.
	Sensor is connected incorrectly.	Connect the connecting cables correctly (terminal diagram).
	Incorrect programming.	Incorrect sensor type set in the Sensor type device function. Set the correct sensor type.

11.2 Diagnostics events

11.2.1 Displaying diagnostics events

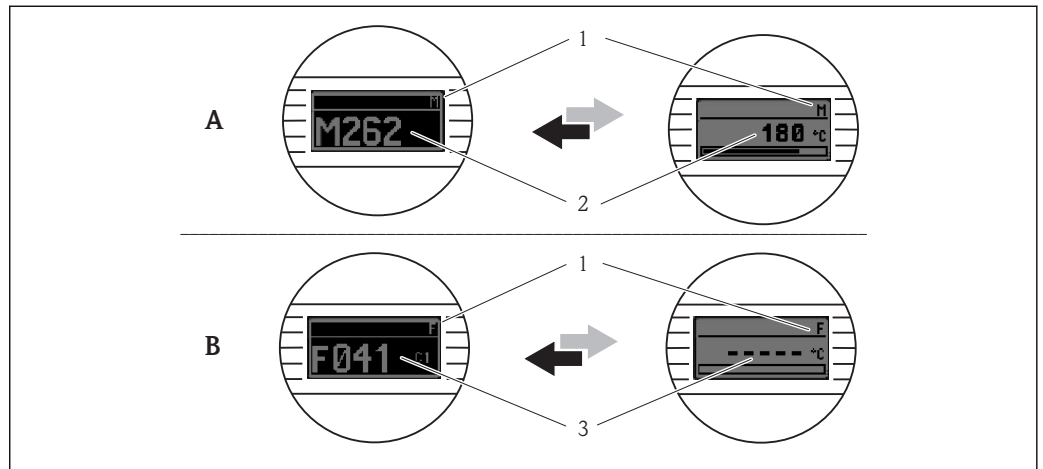

A0014837

A Display in the event of a warning

B Display in the event of an alarm

1 Status signal in the header

2 The display alternates between the primary measured value and the status - indicated by the appropriate letter (M, C or S) - plus the defined error number.

3 The display alternates between "- - -" (no valid measured value) and the status - indicated by the appropriate letter (F) - plus the defined error number.

Status signals

Symbol	Event category	Meaning
F	Operating error	An operating error has occurred. The measured value is no longer valid.
C	Service mode	The device is in service mode (e.g. during a simulation).
S	Out of specification	The device is being operated outside its technical specifications (e.g. during warm-up or cleaning processes).
M	Maintenance required	Maintenance is required. The measured value is still valid.

Diagnostic behavior

Alarm	Measurement is interrupted. The signal outputs assume the defined alarm condition. A diagnostic message is generated (status signal F).
Warning	The device continues to measure. A diagnostic message is generated (status signals M, C or S).

Diagnostics event and event text

The fault can be identified by means of the diagnostics event. The event text helps you by providing information about the fault.

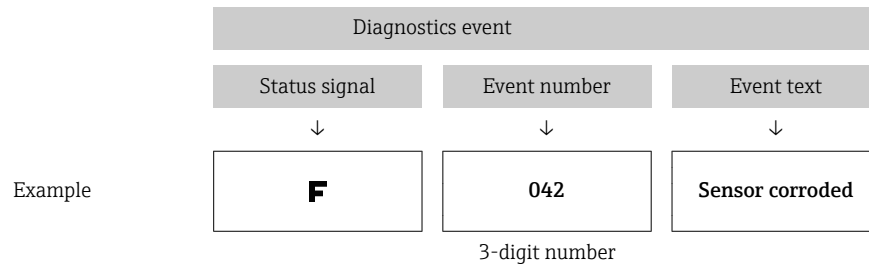

If two or more diagnostics events are pending simultaneously, only the message with the highest priority is shown. Additional pending diagnostic messages are shown in the **Diagnostics list** submenu →  87.

 Past diagnostic messages that are no longer pending are shown in the **Event logbook** submenu →  88.

11.2.2 Overview of diagnostics events

Each diagnostics event is assigned a certain event level at the factory. The user can change this assignment for certain diagnostics events.

 The relevant sensor input for these diagnostics events can be identified by the **Actual diag. channel** parameter or on the optional attachable display.

Diagnostic number	Short text	Corrective measure	Status signal from the factory	Diagnostic behavior from the factory
			Can be changed to	
Diagnostics for the sensor				
001	Device malfunction	1. Reboot device. 2. Check electrical connection of Sensor. 3. Check/replace Sensor. 4. Replace electronics.	F	Alarm
006	Redundancy active	1. Check electrical wiring. 2. Replace sensor. 3. Check connection type.	M	Warning
041	Sensor broken	1. Check electrical wiring. 2. Replace sensor. 3. Check connection type.	F	Alarm
042	Sensor corroded	1. Check electrical wiring of sensor. 2. Replace sensor.	M	Warning ¹⁾
			F	
043	Short circuit	1. Check electronic wiring. 2. Replace sensor.	F	Alarm
044	Sensor drift	1. Check sensors. 2. Check process temperatures.	M	Warning
			F, S	
045	Working area	1. Check ambient temperature. 2. Check external reference measuring point.	F	Alarm

Diagnostic number	Short text	Corrective measure	Status signal from the factory	Diagnostic behavior from the factory
			Can be changed to	
062	Sensor connection	1. Check electrical connection of sensor. 2. Replace sensor. 3. Check sensor configuration. 4. Contact service.	F	Alarm
101	Sensor value too low	1. Check process temperatures. 2. Inspect sensor. 3. Check sensor type.	S	Warning
			F	
102	Sensor value too high	1. Check process temperatures. 2. Inspect sensor. 3. Check sensor type.	S	Warning
			F	
104	Backup active	1. Check electrical wiring of sensor 1. 2. Replace sensor 1. 3. Check connection type.	M	Warning
105	Calibration interval	1. Execute calibration and reset calibration interval. 2. Switch off calibration counter.	M	Warning
			F	
106	Backup not available	1. Check electrical wiring of sensor 2. 2. Replace sensor 2. 3. Check connection type.	M	Warning
Diagnostics for the electronics				
201	Device malfunction	Replace electronics.	F	Alarm
221	Reference measurement	Replace electronics.	F	Alarm
241	Software	1. Restart device. 2. Perform device reset. 3. Replace device.	F	Alarm
242	Software inkompatibel	Contact service.	F	Alarm
261	Electronic modules	Replace electronics.	F	Alarm
262	Module connection short circuit	1. Ensure that display module is correctly seated on the head transmitter. 2. Test the display module using other suitable head transmitters. 3. Display module defective? Replace module.	M	Warning
282	Electronic memory	Replace device.	F	Alarm
283	Memory content	Replace electronics.	F	Alarm
301	Supply voltage	1. Increase supply voltage. 2. Check connection wires for corrosion.	F	Alarm
Diagnostics for the configuration				
401	Factory reset	Please wait until the reset procedure is complete.	C	Warning
402	Initialization	Please wait until the start-up procedure is complete.	C	Warning
410	Data transfer	Check HART communication.	F	Alarm
411	Up-/download	Please wait until the up-/download is complete.	F, M or C ²⁾	-
431	Factory calibration ³⁾	Replace electronics.	F	Alarm

Diagnostic number	Short text	Corrective measure	Status signal from the factory	Diagnostic behavior from the factory
			Can be changed to	
435	Linearization	1. Check configuration of sensor parameters. 2. Check configuration of special sensor linearization. 3. Contact service. 4. Replace electronics.	F	Alarm
437	Configuration	1. Check configuration of sensor parameters. 2. Check configuration of special sensor linearization. 3. Check configuration of transmitter settings. 4. Contact service.	F	Alarm
438	Dataset	Repeat the safe parameterization.	F	Alarm
451	Data processing	Please wait until data processing is complete.	C	Warning
483	Simulation input	Deactivate simulation.	C	Warning
485	Measured value simulation			
491	Simulation current output			
501	CDI connection	Unplug CDI-connector.	C	Warning
525	HART communication	1. Check communication path (Hardware). 2. Check HART- master. 3. Check if power is sufficient. 4. Check HART communication settings. 5. Contact service organisation.	F	Alarm
Diagnostics for the process				
803	Current loop	1. Check wiring. 2. Replace electronics.	F	Alarm
842	Process limit value	Check scaling of analog output.	M F, S	Warning
925	Device temperature	Observe ambient temperature in accordance with specification.	S F	Warning

- 1) Diagnostic behavior can be changed in: "Alarm" or "Warning"
- 2) Status signal depends on used communication system and cannot be changed.
- 3) In the case of this diagnostics event, the device always issues a "low" alarm status (output current ≤ 3.6 mA).

11.3 Spare parts

Currently available spare parts for your product can be found online at:

http://www.products.endress.com/spareparts_consumables, HART® Temperature

transmitter: TMT82. When ordering spare parts, please quote the serial number of the device!

Type	Order number
Standard - DIN securing set (2 screws and springs, 4 shaft lock-down rings, 1 plug for the display interface)	71044061
US - M4 securing set (2 screws and 1 plug for the display interface)	71044062
TID10 service cable; connecting cable for service interface, 40 cm	71086650
Commubox FXA195 HART®, for intrinsically safe HART communication with FieldCare via the USB interface.	FXA195-.....
Spare parts kit for DIN rail transmitter (terminals and fixing lever housing)	XPT0003-A1

11.4 Return

The measuring device must be returned if it is need of repair or a factory calibration, or if the wrong measuring device has been delivered or ordered. Legal specifications require Endress+Hauser, as an ISO-certified company, to follow certain procedures when handling products that are in contact with the medium.

To ensure safe, swift and professional device returns, please refer to the procedure and conditions for returning devices provided on the Endress+Hauser website at <http://www.endress.com/support/return-material>

11.5 Disposal

The device contains electronic components and must therefore be disposed of as electronic waste. Please pay particular attention to the national disposal regulations in your country.

11.6 Software history and overview of compatibility

Revision history

The firmware version (FW) on the nameplate and in the Operating Instructions indicates the device release: XX.YY.ZZ (example 01.02.01).

XX	Change to main version. No longer compatible. The device and Operating Instructions change.
YY	Change to functions and operation. Compatible. The Operating Instructions change.
ZZ	Fixes and internal changes. No changes to the Operating Instructions.

Date	Firmware Version	Modifications	Documentation
01/11	01.00.zz	Original firmware	BA01028T/09/en/13.10
10/12	01.00.zz	No changes to functions and operation.	BA01028T/09/en/14.12
02/14	01.01.zz	Functional safety (SIL3)	BA01028T/09/en/15.13
02/17	01.01.zz	Changes in configuration parameter for Functional safety (SIL3)	BA01028T/09/en/17.17

12 Technical data

 For secure HART® communication in accordance with functional safety as defined in IEC 61508 (SIL mode), measured values are sent securely from the transmitter via the HART® protocol to a connected control system where they are processed further in a secure manner. Secure HART® communication works using special HART® commands that are only available in the SIL mode.

The secure HART® protocol includes technologies that are licensed by Rockwell Automation.

 For more information please refer to the Functional Safety Manual SD01172T/09

12.1 Input

Measured variable Temperature (temperature-linear transmission behavior), resistance and voltage.

Measuring range It is possible to connect two sensors that are independent of one another¹⁾. The measuring inputs are not galvanically isolated from each other.

Resistance thermometer (RTD) as per standard	Description	α	Measuring range limits	Min. span
IEC 60751:2008	Pt100 (1) Pt200 (2) Pt500 (3) Pt1000 (4)	0.003851	-200 to +850 °C (-328 to +1562 °F) -200 to +850 °C (-328 to +1562 °F) -200 to +500 °C (-328 to +932 °F) -200 to +250 °C (-328 to +482 °F)	10 K (18 °F)
JIS C1604:1984	Pt100 (5)	0.003916	-200 to +510 °C (-328 to +950 °F)	10 K (18 °F)
DIN 43760 IPTS-68	Ni100 (6) Ni120 (7)	0.006180	-60 to +250 °C (-76 to +482 °F) -60 to +250 °C (-76 to +482 °F)	10 K (18 °F)
GOST 6651-94	Pt50 (8) Pt100 (9)	0.003910	-185 to +1100 °C (-301 to +2012 °F) -200 to +850 °C (-328 to +1562 °F)	10 K (18 °F)
OIML R84: 2003, GOST 6651-2009	Cu50 (10) Cu100 (11)	0.004280	-180 to +200 °C (-292 to +392 °F) -180 to +200 °C (-292 to +392 °F)	10 K (18 °F)
	Ni100 (12) Ni120 (13)	0.006170	-60 to +180 °C (-76 to +356 °F) -60 to +180 °C (-76 to +356 °F)	10 K (18 °F)
OIML R84: 2003, GOST 6651-94	Cu50 (14)	0.004260	-50 to +200 °C (-58 to +392 °F)	10 K (18 °F)
-	Pt100 (Callendar van Dusen) Nickel polynomial Copper polynomial	-	The measuring range limits are specified by entering the limit values that depend on the coefficients A to C and R0.	10 K (18 °F)
<ul style="list-style-type: none"> ▪ Type of connection: 2-wire, 3-wire or 4-wire connection, sensor current: ≤0.3 mA ▪ With 2-wire circuit, compensation of wire resistance possible (0 to 30 Ω) ▪ With 3-wire and 4-wire connection, sensor wire resistance up to max. 50 Ω per wire 				
Resistance transmitter	Resistance Ω		10 to 400 Ω 10 to 2 000 Ω	10 Ω 10 Ω

1) In the case of 2-channel measurement the same measuring unit must be configured for the two channels (e.g. both °C or F or K). Independent 2-channel measurement of a resistance transmitter (Ohm) and voltage transmitter (mV) is not possible.

Thermocouples as per standard	Description	Measuring range limits		Min. span
IEC 60584, Part 1	Type A (W5Re-W20Re) (30) Type B (PtRh30-PtRh6) (31) Type E (NiCr-CuNi) (34) Type J (Fe-CuNi) (35) Type K (NiCr-Ni) (36) Type N (NiCrSi-NiSi) (37) Type R (PtRh13-Pt) (38) Type S (PtRh10-Pt) (39) Type T (Cu-CuNi) (40)	0 to +2 500 °C (+32 to +4 532 °F) +40 to +1 820 °C (+104 to +3 308 °F) -270 to +1 000 °C (-454 to +1 832 °F) -210 to +1 200 °C (-346 to +2 192 °F) -270 to +1 372 °C (-454 to +2 501 °F) -270 to +1 300 °C (-454 to +2 372 °F) -50 to +1 768 °C (-58 to +3 214 °F) -50 to +1 768 °C (-58 to +3 214 °F) -260 to +400 °C (-436 to +752 °F)	Recommended temperature range: 0 to +2 500 °C (+32 to +4 532 °F) +500 to +1 820 °C (+932 to +3 308 °F) -150 to +1 000 °C (-238 to +1 832 °F) -150 to +1 200 °C (-238 to +2 192 °F) -150 to +1 200 °C (-238 to +2 192 °F) -150 to +1 300 °C (-238 to +2 372 °F) +50 to +1 768 °C (+122 to +3 214 °F) +50 to +1 768 °C (+122 to +3 214 °F) -150 to +400 °C (-238 to +752 °F)	50 K (90 °F) 50 K (90 °F) 50 K (90 °F) 50 K (90 °F) 50 K (90 °F) 50 K (90 °F) 50 K (90 °F) 50 K (90 °F) 50 K (90 °F)
IEC 60584, Part 1; ASTM E988-96	Type C (W5Re-W26Re) (32)	0 to +2 315 °C (+32 to +4 199 °F)	0 to +2 000 °C (+32 to +3 632 °F)	50 K (90 °F)
ASTM E988-96	Type D (W3Re-W25Re) (33)	0 to +2 315 °C (+32 to +4 199 °F)	0 to +2 000 °C (+32 to +3 632 °F)	50 K (90 °F)
DIN 43710	Type L (Fe-CuNi) (41) Type U (Cu-CuNi) (42)	-200 to +900 °C (-328 to +1 652 °F) -200 to +600 °C (-328 to +1 112 °F)	-150 to +900 °C (-238 to +1 652 °F) -150 to +600 °C (-238 to +1 112 °F)	50 K (90 °F)
GOST R8.8585-2001	Type L (NiCr-CuNi) (43)	-200 to +800 °C (-328 to +1 472 °F)	-200 to +800 °C (+328 to +1 472 °F)	50 K (90 °F)
	<ul style="list-style-type: none"> Internal cold junction (Pt100) External cold junction: configurable value -40 to +85 °C (-40 to +185 °F) Maximum sensor wire resistance 10 kΩ (If the sensor wire resistance is greater than 10 kΩ, an error message is output in accordance with NAMUR NE89.) 			
Voltage transmitter (mV)	Millivolt transmitter (mV)	-20 to 100 mV		5 mV

Type of input

The following connection combinations are possible when both sensor inputs are assigned:

		Sensor input 1			Thermocouple (TC), voltage transmitter
		RTD or resistance transmitter, 2-wire	RTD or resistance transmitter, 3-wire	RTD or resistance transmitter, 4-wire	
Sensor input 2	RTD or resistance transmitter, 2-wire	☑	☑	-	☑
	RTD or resistance transmitter, 3-wire	☑	☑	-	☑
	RTD or resistance transmitter, 4-wire	-	-	-	-
	Thermocouple (TC), voltage transmitter	☑	☑	☑	☑

12.2 Output

Output signal

Analog output	4 to 20 mA, 20 to 4 mA (can be inverted)
Signal encoding	FSK ±0.5 mA via current signal
Data transmission rate	1200 baud
Galvanic isolation	U = 2 kV AC (input/output)

Failure information

Failure information as per NAMUR NE43:

Failure information is created if the measuring information is missing or not valid. A complete list of all the errors occurring in the measuring system is created.

Underranging	Linear drop from 4.0 to 3.8 mA
Overranging	Linear increase from 20.0 to 20.5 mA
Failure, e.g. sensor breakage, sensor short-circuit	≤ 3.6 mA ("low") or ≥ 21 mA ("high"), can be selected The "high" alarm setting can be set between 21.5 mA and 23 mA, thus providing the flexibility needed to meet the requirements of various control systems. Only the "low" alarm setting is possible in the SIL mode.

Load

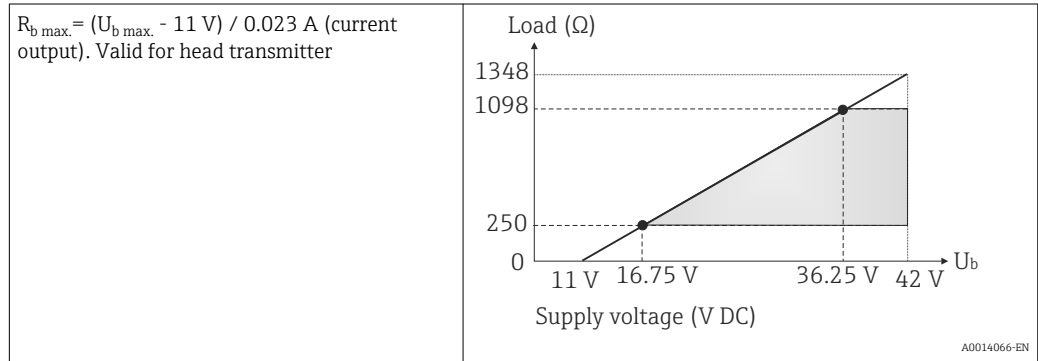

Linearization/transmission behavior Temperature-linear, resistance-linear, voltage-linear

Network frequency filter 50/60 Hz

Filter 1st order digital filter: 0 to 120 s

Protocol-specific data

HART® version	7
Device address in the multi-drop mode ¹⁾	Software setting addresses 0 to 63
Device description files (DD)	Information and files are available free of charge at: www.endress.com www.hartcomm.org
Load (communication resistor)	min. 250 Ω

1) Not possible in the SIL mode, see Functional Safety Manual SD01172T/09

Write protection for device parameters

- Hardware: Write protection for head transmitter on optional display using DIP switch
- Software: Write protection using password

Switch-on delay

- Until start of HART® communication, approx. 10 s ²⁾, with switch-on delay = $I_a \leq 3.8 \text{ mA}$
- Until the first valid measured value signal is present at the current output, approx. 28 s, with switch-on delay = $I_a \leq 3.8 \text{ mA}$

2) Does not apply for the SIL mode, see Functional Safety Manual SD01172T/09

12.3 Power supply

Supply voltage

Values for non-hazardous areas, protected against polarity reversal:

- Head transmitter
 - $11\text{ V} \leq V_{cc} \leq 42\text{ V}$ (standard)
 - $11\text{ V} \leq V_{cc} \leq 32\text{ V}$ (SIL mode)
 - $I: \leq 23\text{ mA}$
- DIN rail device
 - $12\text{ V} \leq V_{cc} \leq 42\text{ V}$ (standard)
 - $12\text{ V} \leq V_{cc} \leq 32\text{ V}$ (SIL mode)
 - $I: < 23\text{ mA}$

Values for hazardous areas, see Ex documentation .

Current consumption

- 3.6 to 23 mA
- Minimum current consumption 3.5 mA, multi-drop mode 4 mA (not possible in the SIL mode)
- Current limit $\leq 23\text{ mA}$

Terminals

Choice of screw or spring terminals for sensor and fieldbus cables:

	Terminal version	Cable version	Cable cross-section
Head transmitter / DIN rail device	Screw terminals	Rigid or flexible	$\leq 2.5\text{ mm}^2$ (14 AWG)
Head transmitter			
Head transmitter	Spring terminals (cable version, stripping length = min. 10 mm (0.39 in))	Rigid or flexible	0.2 to 1.5 mm ² (24 to 16 AWG)
		Flexible with wire end ferrules without plastic ferrule	0.25 to 1.5 mm ² (24 to 16 AWG)
		Flexible with wire end ferrules with plastic ferrule	0.25 to 0.75 mm ² (24 to 18 AWG)

 When connecting flexible cables to spring terminals, it is recommended not to use wire end ferrules.

Residual ripple

Permanent residual ripple $U_{ss} \leq 3\text{ V}$ at $U_b \geq 13.5\text{ V}$, $f_{max.} = 1\text{ kHz}$

12.4 Performance characteristics

Response time

The measured value update depends on the type of sensor and connection method and moves within the following ranges:

Resistance thermometer (RTD)	0.9 to 1.3 s (depends on the connection method 2/3/4-wire)
Thermocouples (TC)	0.8 s
Reference temperature	0.9 s

 When recording step responses, it must be taken into account that the times for the measurement of the second channel and the internal reference measuring point are added to the specified times where applicable.

Reference operating conditions

- Calibration temperature: +25 °C ±3 K (77 °F ±5.4 °F)
- Supply voltage: 24 V DC
- 4-wire circuit for resistance adjustment

Maximum measured error In accordance with DIN EN 60770 and the reference conditions specified above. The measured error data correspond to 2 σ (Gaussian distribution). The data include non-linearities and repeatability.

Typical

Standard	Description	Measuring range	Typical measured error (±)	
Resistance thermometer (RTD) as per standard			Digital value ¹⁾	Value at current output
IEC 60751:2008	Pt100 (1)	0 to +200 °C (32 to +392 °F)	0.08 °C (0.14 °F)	0.1 °C (0.18 °F)
IEC 60751:2008	Pt1000 (4)		0.08 K (0.14 °F)	0.1 °C (0.18 °F)
GOST 6651-94	Pt100 (9)		0.07 °C (0.13 °F)	0.09 °C (0.16 °F)
Thermocouples (TC) as per standard			Digital value ¹⁾	Value at current output
IEC 60584, Part 1	Type K (NiCr-Ni) (36)	0 to +800 °C (32 to +1 472 °F)	0.31 °C (0.56 °F)	0.39 °C (0.7 °F)
IEC 60584, Part 1	Type S (PtRh10-Pt) (39)		0.97 °C (1.75 °F)	1.0 °C (1.8 °F)
GOST R8.8585-2001	Type L (NiCr-CuNi) (43)		2.18 °C (3.92 °F)	2.2 °C (3.96 °F)

1) Measured value transmitted via HART®.

Measured error for resistance thermometers (RTD) and resistance transmitters

Standard	Description	Measuring range	Measured error (±)		D/A ²⁾
			Digital ¹⁾		
			Maximum ³⁾	Based on measured value	
IEC 60751:2008	Pt100 (1)	-200 to +850 °C (-328 to +1 562 °F)	≤0.12 °C (0.21 °F)	0.06 °C (0.11 °F) + 0.006% x (MV - LRV)	0.03 % (≅ 4.8 μA)
	Pt200 (2)		≤0.30 °C (0.54 °F)	0.11 °C (0.2 °F) + 0.018% x (MV - LRV)	
	Pt500 (3)	-200 to +510 °C (-328 to +950 °F)	≤0.16 °C (0.29 °F)	0.05 °C (0.09 °F) + 0.015% x (MV - LRV)	
	Pt1000 (4)	-200 to +250 °C (-328 to +482 °F)	≤0.09 °C (0.16 °F)	0.03 °C (0.05 °F) + 0.013% x (MV - LRV)	
JIS C1604:1984	Pt100 (5)	-200 to +510 °C (-328 to +950 °F)		0.05 °C (0.09 °F) + 0.006% x (MV - LRV)	
GOST 6651-94	Pt50 (8)	-185 to +1 100 °C (-301 to +2 012 °F)	≤0.20 °C (0.36 °F)	0.1 °C (0.18 °F) + 0.008% x (MV - LRV)	
	Pt100 (9)	-200 to +850 °C (-328 to +1 562 °F)	≤0.11 °C (0.2 °F)	0.05 °C (0.09 °F) + 0.006% x (MV - LRV)	
DIN 43760 IPTS-68	Ni100 (6)	-60 to +250 °C (-76 to +482 °F)	≤0.05 °C (0.09 °F)	0.05 °C (0.09 °F) + 0.006% x (MV - LRV)	
	Ni120 (7)				
OIML R84: 2003 / GOST 6651-2009	Cu50 (10)	-180 to +200 °C (-292 to +392 °F)	≤0.11 °C (0.2 °F)	0.09 °C (0.16 °F) + 0.006% x (MV - LRV)	
	Cu100 (11)	-180 to +200 °C (-292 to +392 °F)	≤0.06 °C (0.11 °F)	0.05 °C (0.09 °F) + 0.003% x (MV - LRV)	
	Ni100 (12)	-60 to +180 °C (-76 to +356 °F)	≤0.05 °C (0.09 °F)	0.05 °C (0.09 °F) + 0.005% x (MV - LRV)	
	Ni120 (13)				

Standard	Description	Measuring range	Measured error (\pm)		
OIML R84: 2003, GOST 6651-94	Cu50 (14)	-50 to +200 °C (-58 to +392 °F)	≤ 0.11 °C (0.2 °F)	0.1 °C (0.18 °F) + 0.004% x (MV - LRV)	
Resistance transmitter	Resistance Ω	10 to 400 Ω 10 to 2 000 Ω	32 m Ω 300 m Ω	-	0.03 % (\cong 4.8 μ A)

- 1) Measured value transmitted via HART®.
- 2) Percentages based on the configured span of the analog output signal.
- 3) Maximum measured error for the specified measuring range

Measured error for thermocouples (TC) and voltage transmitters

Standard	Description	Measuring range	Measured error (\pm)		D/A ²⁾
			Digital ¹⁾		
			Maximum ³⁾	Based on measured value	
IEC 60584-1	Type A (30)	0 to +2 500 °C (+32 to +4 532 °F)	≤ 1.31 °C (2.36 °F)	0.8 °C (1.44 °F) + 0.021% x MV	0.03 % (\cong 4.8 μ A)
	Type B (31)	+500 to +1 820 °C (+932 to +3 308 °F)	≤ 1.43 °C (2.57 °F)	1.5 °C (2.7 °F) + 0.06% x (MV - LRV)	
IEC 60584-1 / ASTM E988-96	Type C (32)	0 to +2 000 °C (+32 to +3 632 °F)	≤ 0.66 °C (1.19 °F)	0.55 °C (1.0 °F) + 0.0055% x MV	
ASTM E988-96	Type D (33)		≤ 0.74 °C (1.33 °F)	0.74 °C (1.33 °F) + 0.008% x MV	
IEC 60584-1	Type E (34)	-150 to +1 000 °C (-238 to +1 832 °F)	≤ 0.22 °C (0.4 °F)	0.22 °C (0.4 °F) + 0.006% x (MV - LRV)	
	Type J (35)	-150 to +1 200 °C (-238 to +2 192 °F)	≤ 0.27 °C (0.49 °F)	0.27 °C (0.49 °F) + 0.005% x (MV - LRV)	
	Type K (36)		≤ 0.35 °C (0.63 °F)	0.35 °C (0.63 °F) + 0.005% x (MV - LRV)	
	Type N (37)		-150 to +1 300 °C (-238 to +2 372 °F)	≤ 0.47 °C (0.85 °F)	
	Type R (38)	+50 to +1 768 °C (+122 to +3 214 °F)	≤ 1.11 °C (1.98 °F)	1.12 °C (2.0 °F) + 0.03% x (MV - LRV)	
	Type S (39)		≤ 1.14 °C (2.05 °F)	1.15 °C (2.07 °F) + 0.022% x (MV - LRV)	
Type T (40)	-150 to +400 °C (-238 to +752 °F)	≤ 0.35 °C (0.63 °F)	0.36 °C (0.65 °F) + 0.04% x (MV - LRV)		
DIN 43710	Type L (41)	-150 to +900 °C (-238 to +1 652 °F)	≤ 0.29 °C (0.52 °F)	0.29 °C (0.52 °F) + 0.009% x (MV - LRV)	
	Type U (42)	-150 to +600 °C (-238 to +1 112 °F)	≤ 0.32 °C (0.58 °F)	0.33 °C (0.6 °F) + 0.028% x (MV - LRV)	
GOST R8.8585-2001	Type L (43)	-200 to +800 °C (-328 to +1 472 °F)	≤ 2.16 °C (3.89 °F)	2.2 °C (3.96 °F) + 0.015% x (MV - LRV)	
Voltage transmitter (mV)		-20 to +100 mV	10 μ V	7.7 μ V + 0.0025% x (MV - LRV)	4.8 μ A

- 1) Measured value transmitted via HART®.
- 2) Percentages based on the configured span of the analog output signal.
- 3) Maximum measured error for the specified measuring range

MV = Measured Value

LRV = Lower Range Value of relevant sensor

Total measured error of transmitter at current output = $\sqrt{(\text{Measured error digital}^2 + \text{Measured error D/A}^2)}$

Sample calculation with Pt100, measuring range 0 to +200 °C (+32 to +392 °F), ambient temperature +25 °C (+77 °F), supply voltage 24 V:

Measured error digital = $0.06\text{ °C} + 0.006\% \times (200\text{ °C} - (-200\text{ °C}))$:	0.084 °C (0.151 °F)
Measured error D/A = $0.03\% \times 200\text{ °C}$ (360 °F)	0.06 °C (0.108 °F)
Measured error digital value (HART):	0.084 °C (0.151 °F)
Measured error analog value (current output): $\sqrt{(\text{Measured error digital}^2 + \text{Measured error D/A}^2)}$	0.103 °C (0.185 °F)

Sample calculation with Pt100, measuring range 0 to +200 °C (+32 to +392 °F), ambient temperature +35 °C (+95 °F), supply voltage 30 V:

Measured error digital = $0.06\text{ °C} + 0.006\% \times (200\text{ °C} - (-200\text{ °C}))$:	0.084 °C (0.151 °F)
Measured error D/A = $0.03\% \times 200\text{ °C}$ (360 °F)	0.06 °C (0.108 °F)
Influence of ambient temperature (digital) = $(35 - 25) \times (0.002\% \times 200\text{ °C} - (-200\text{ °C}))$, min. 0.005 °C	0.08 °C (0.144 °F)
Influence of ambient temperature (D/A) = $(35 - 25) \times (0.001\% \times 200\text{ °C})$	0.02 °C (0.036 °F)
Influence of supply voltage (digital) = $(30 - 24) \times (0.002\% \times 200\text{ °C} - (-200\text{ °C}))$, min. 0.005 °C	0.048 °C (0.086 °F)
Influence of supply voltage (D/A) = $(30 - 24) \times (0.001\% \times 200\text{ °C})$	0.012 °C (0.022 °F)
Measured error digital value (HART): $\sqrt{(\text{Measured error digital}^2 + \text{Influence of ambient temperature (digital)}^2 + \text{Influence of supply voltage (digital)}^2)}$	0.126 °C (0.227 °F)
Measured error analog value (current output): $\sqrt{(\text{Measured error digital}^2 + \text{Measured error D/A}^2 + \text{Influence of ambient temperature (digital)}^2 + \text{Influence of ambient temperature (D/A)}^2 + \text{Influence of supply voltage (digital)}^2 + \text{Influence of supply voltage (D/A)}^2)}$	0.141 °C (0.254 °F)

The measured error data correspond to 2 σ (Gaussian distribution).

MV = Measured Value

LRV = Lower Range Value of relevant sensor

Physical input measuring range of sensors	
10 to 400 Ω	Cu50, Cu100, polynomial RTD, Pt50, Pt100, Ni100, Ni120
10 to 2 000 Ω	Pt200, Pt500, Pt1000
-20 to 100 mV	Thermocouples type: A, B, C, D, E, J, K, L, N, R, S, T, U

 Other measured errors apply in SIL mode.

 For more information please refer to the Functional Safety Manual SD01172T/09.

Sensor transmitter matching

RTD sensors are one of the most linear temperature measuring elements. Nevertheless, the output must be linearized. To significantly improve temperature measurement accuracy, the device allows the use of two methods:

■ Callendar-Van-Dusen coefficients (Pt100 resistance thermometer)

The Callendar-Van-Dusen equation is described as:

$$R_T = R_0[1 + AT + BT^2 + C(T - 100)T^3]$$

The coefficients A, B and C are used to match the sensor (platinum) and transmitter in order to improve the accuracy of the measuring system. The coefficients for a standard sensor are specified in IEC 751. If no standard sensor is available or if greater accuracy is required, the coefficients for each sensor can be determined specifically with the aid of sensor calibration.

■ Linearization for copper/nickel resistance thermometers (RTD)

The polynomial equation for copper/nickel is as follows:

$$R_T = R_0(1 + AT + BT^2)$$

The coefficients A and B are used for the linearization of nickel or copper resistance thermometers (RTD). The exact values of the coefficients derive from the calibration data and are specific to each sensor. The sensor-specific coefficients are then sent to the transmitter.

Sensor transmitter matching using one of the methods explained above significantly improves the temperature measurement accuracy of the entire system. This is because the transmitter uses the specific data pertaining to the connected sensor to calculate the measured temperature, instead of using the standardized sensor curve data.

1-point adjustment (offset)

Shifts the sensor value

2-point adjustment (sensor trimming)

Correction (slope and offset) of the measured sensor value at transmitter input

Current output adjustment Correction of 4 or 20 mA current output value (not possible in SIL mode)

Operating influences The measured error data correspond to 2σ (Gaussian distribution).

Influence of ambient temperature and supply voltage on operation for resistance thermometers (RTD) and resistance transmitters

Description	Standard	Ambient temperature: Influence (\pm) per 1 °C (1.8 °F) change			Supply voltage: Influence (\pm) per V change		
		Digital ¹⁾		D/A ²⁾	Digital ¹⁾		D/A ²⁾
		Maximum	Based on measured value		Maximum	Based on measured value	
Pt100 (1)	IEC 60751:2008	≤ 0.02 °C (0.036 °F)	0.002% x (MV -LRV), at least 0.005 °C (0.009 °F)	0.001 %	≤ 0.02 °C (0.036 °F)	0.002% x (MV -LRV), at least 0.005 °C (0.009 °F)	0.001 %
Pt200 (2)		≤ 0.026 °C (0.047 °F)	-		≤ 0.026 °C (0.047 °F)	-	
Pt500 (3)		≤ 0.014 °C (0.025 °F)	0.002% x (MV -LRV), at least 0.009 °C (0.016 °F)		≤ 0.014 °C (0.025 °F)	0.002% x (MV -LRV), at least 0.009 °C (0.016 °F)	
Pt1000 (4)	JIS C1604:1984	≤ 0.01 °C (0.018 °F)	0.002% x (MV -LRV), at least 0.004 °C (0.007 °F)		≤ 0.01 °C (0.018 °F)	0.002% x (MV -LRV), at least 0.004 °C (0.007 °F)	
Pt100 (5)		0.002% x (MV -LRV), at least 0.005 °C (0.009 °F)	0.002% x (MV -LRV), at least 0.005 °C (0.009 °F)				
Pt50 (8)	GOST 6651-94	≤ 0.03 °C (0.054 °F)	0.002% x (MV -LRV), at least 0.01 °C (0.018 °F)		≤ 0.03 °C (0.054 °F)	0.002% x (MV -LRV), at least 0.01 °C (0.018 °F)	
Pt100 (9)		≤ 0.02 °C (0.036 °F)	0.002% x (MV -LRV), at least 0.005 °C (0.009 °F)		≤ 0.02 °C (0.036 °F)	0.002% x (MV -LRV), at least 0.005 °C (0.009 °F)	

Description	Standard	Ambient temperature: Influence (±) per 1 °C (1.8 °F) change		Supply voltage: Influence (±) per V change			
Ni100 (6)	DIN 43760 IPTS-68	≤ 0.005 °C (0.009 °F)	-	≤ 0.005 °C (0.009 °F)	-		
Ni120 (7)		-	-				
Cu50 (10)	OIML R84: 2003 / GOST 6651-2009	≤ 0.008 °C (0.014 °F)	0.002% x (MV -LRV), at least 0.004 °C (0.007 °F)	≤ 0.008 °C (0.014 °F)	0.002% x (MV -LRV), at least 0.004 °C (0.007 °F)		
Cu100 (11)		-	-				
Ni100 (12)		≤ 0.004 °C (0.007 °F)	-	≤ 0.004 °C (0.007 °F)	-		
Ni120 (13)		-	-	-	-		
Cu50 (14)		OIML R84: 2003 / GOST 6651-94	≤ 0.008 °C (0.014 °F)	-	≤ 0.008 °C (0.014 °F)	-	
Resistance transmitter (Ω)							
10 to 400 Ω		≤ 6 mΩ	0.015% x (MV -LRV), at least 1.5 mΩ	0.001 %	≤ 6 mΩ	0.015% x (MV -LRV), at least 1.5 mΩ	0.001 %
10 to 2 000 Ω		≤ 30 mΩ	0.0015% x (MV -LRV), at least 15 mΩ		≤ 30 mΩ	0.0015% x (MV -LRV), at least 15 mΩ	

- 1) Measured value transmitted via HART®.
- 2) Percentages based on the configured span of the analog output signal

Influence of ambient temperature and supply voltage on operation for thermocouples (TC) and voltage transmitters

Description	Standard	Ambient temperature: Influence (±) per 1 °C (1.8 °F) change		Supply voltage: Influence (±) per V change			
		Digital ¹⁾		D/A ²⁾	Digital		D/A ²⁾
		Maximum	Based on measured value		Maximum	Based on measured value	
Type A (30)	IEC 60584-1	≤ 0.14 °C (0.25 °F)	0.0055% x (MV -LRV), at least 0.03 °C (0.054 °F)	0.001 %	≤ 0.14 °C (0.25 °F)	0.0055% x (MV -LRV), at least 0.03 °C (0.054 °F)	0.001 %
Type B (31)		≤ 0.06 °C (0.11 °F)	-		≤ 0.06 °C (0.11 °F)	-	
Type C (32)	IEC 60584-1 / ASTM E988-96	≤ 0.09 °C (0.16 °F)	0.0045% x (MV -LRV), at least 0.03 °C (0.054 °F)		≤ 0.09 °C (0.16 °F)	0.0045% x (MV -LRV), at least 0.03 °C (0.054 °F)	
Type D (33)	ASTM E988-96	≤ 0.08 °C (0.14 °F)	0.004% x (MV -LRV), at least 0.035 °C (0.063 °F)		≤ 0.08 °C (0.14 °F)	0.004% x (MV -LRV), at least 0.035 °C (0.063 °F)	
Type E (34)	IEC 60584-1	≤ 0.03 °C (0.05 °F)	0.003% x (MV -LRV), at least 0.016 °C (0.029 °F)		≤ 0.03 °C (0.05 °F)	0.003% x (MV -LRV), at least 0.016 °C (0.029 °F)	
Type J (35)		≤ 0.02 °C (0.04 °F)	0.0028% x (MV -LRV), at least 0.02 °C (0.036 °F)		≤ 0.02 °C (0.04 °F)	0.0028% x (MV -LRV), at least 0.02 °C (0.036 °F)	
Type K (36)		≤ 0.04 °C (0.07 °F)	0.003% x (MV -LRV), at least 0.013 °C (0.023 °F)		≤ 0.04 °C (0.07 °F)	0.003% x (MV -LRV), at least 0.013 °C (0.023 °F)	
Type N (37)			0.0028% x (MV -LRV), at least 0.020 °C (0.036 °F)			0.0028% x (MV -LRV), at least 0.020 °C (0.036 °F)	
Type R (38)		≤ 0.06 °C (0.11 °F)	0.0035% x (MV -LRV), at least 0.047 °C (0.085 °F)		≤ 0.06 °C (0.11 °F)	0.0035% x (MV -LRV), at least 0.047 °C (0.085 °F)	
Type S (39)		≤ 0.05 °C (0.09 °F)	-		≤ 0.05 °C (0.09 °F)	-	
Type T (40)		≤ 0.01 °C (0.02 °F)	-		≤ 0.01 °C (0.02 °F)	-	
Type L (41)		DIN 43710	≤ 0.02 °C (0.04 °F)		-	≤ 0.02 °C (0.04 °F)	
Type U (42)	≤ 0.01 °C (0.02 °F)		-	≤ 0.01 °C (0.02 °F)	-		

Description	Standard	Ambient temperature: Influence (±) per 1 °C (1.8 °F) change			Supply voltage: Influence (±) per V change		
		≤ 0.01 °C (0.02 °F)	-		≤ 0.01 °C (0.02 °F)	-	
Type L (43)	GOST R8.8585-2001	≤ 0.01 °C (0.02 °F)	-		≤ 0.01 °C (0.02 °F)	-	
Voltage transmitter (mV)				0.001 %			
-20 to 100 mV	-	≤ 3 μV	-		≤ 3 μV	-	0.001 %

- 1) Measured value transmitted via HART®.
- 2) Percentages based on the configured span of the analog output signal

MV = Measured Value

LRV = Lower Range Value of relevant sensor

Total measured error of transmitter at current output = $\sqrt{(\text{Measured error digital}^2 + \text{Measured error D/A}^2)}$

Long-term drift, resistance thermometers (RTD) and resistance transmitters

Description	Standard	Long-term drift (±)		
		after 1 year	after 3 years	after 5 years
		Based on measured value		
Pt100 (1)	IEC 60751:2008	≤ 0.03 °C (0.05 °F) + 0.024% x span	≤ 0.042 °C (0.076 °F) + 0.035% x span	≤ 0.051 °C (0.092 °F) + 0.037% x span
Pt200 (2)		≤ 0.17 °C (0.31 °F) + 0.016% x span	≤ 0.28 °C (0.5 °F) + 0.022% x span	≤ 0.343 °C (0.617 °F) + 0.025% x span
Pt500 (3)		≤ 0.067 °C (0.121 °F) + 0.018% x span	≤ 0.111 °C (0.2 °F) + 0.025% x span	≤ 0.137 °C (0.246 °F) + 0.028% x span
Pt1000 (4)		≤ 0.034 °C (0.06 °F) + 0.02% x span	≤ 0.056 °C (0.1 °F) + 0.029% x span	≤ 0.069 °C (0.124 °F) + 0.032% x span
Pt100 (5)	JIS C1604:1984	≤ 0.03 °C (0.054 °F) + 0.022% x span	≤ 0.042 °C (0.076 °F) + 0.032% x span	≤ 0.051 °C (0.092 °F) + 0.034% x span
Pt50 (8)	GOST 6651-94	≤ 0.055 °C (0.1 °F) + 0.023% x span	≤ 0.089 °C (0.16 °F) + 0.032% x span	≤ 0.1 °C (0.18 °F) + 0.035% x span
Pt100 (9)		≤ 0.03 °C (0.054 °F) + 0.024% x span	≤ 0.042 °C (0.076 °F) + 0.034% x span	≤ 0.051 °C (0.092 °F) + 0.037% x span
Ni100 (6)	DIN 43760 IPTS-68	≤ 0.025 °C (0.045 °F) + 0.016% x span	≤ 0.042 °C (0.076 °F) + 0.02% x span	≤ 0.047 °C (0.085 °F) + 0.021% x span
Ni120 (7)		≤ 0.021 °C (0.038 °F) + 0.018% x span	≤ 0.032 °C (0.058 °F) + 0.024% x span	≤ 0.036 °C (0.065 °F) + 0.025% x span
Cu50 (10)	OIML R84: 2003 / GOST 6651-2009	≤ 0.053 °C (0.095 °F) + 0.013% x span	≤ 0.084 °C (0.151 °F) + 0.016% x span	≤ 0.094 °C (0.169 °F) + 0.016% x span
Cu100 (11)		≤ 0.027 °C (0.049 °F) + 0.019% x span	≤ 0.042 °C (0.076 °F) + 0.026% x span	≤ 0.047 °C (0.085 °F) + 0.027% x span
Ni100 (12)		≤ 0.026 °C (0.047 °F) + 0.015% x span	≤ 0.04 °C (0.076 °F) + 0.02% x span	≤ 0.046 °C (0.083 °F) + 0.02% x span
Ni120 (13)		≤ 0.021 °C (0.038 °F) + 0.017% x span	≤ 0.034 °C (0.061 °F) + 0.022% x span	≤ 0.038 °C (0.068 °F) + 0.023% x span
Cu50 (14)	OIML R84: 2003 / GOST 6651-94	≤ 0.056 °C (0.1 °F) + 0.009% x span	≤ 0.089 °C (0.16 °F) + 0.011% x span	≤ 0.1 °C (0.18 °F) + 0.011% x span
Resistance transmitter				
10 to 400 Ω		≤ 10mΩ + 0.022% x span	≤ 14mΩ + 0.031% x span	≤ 16mΩ + 0.033% x span
10 to 2000 Ω		≤ 144mΩ + 0.019% x span	≤ 238mΩ + 0.026% x span	≤ 294mΩ + 0.028% x span

Long-term drift, thermocouples (TC) and voltage transmitters

Description	Standard	Long-term drift (±)		
		after 1 year	after 3 years	after 5 years
		Based on measured value		
Type A (30)	IEC 60584-1	$\leq 0.17\text{ °C (0.306 °F) + 0.021\% \times \text{span}}$	$\leq 0.27\text{ °C (0.486 °F) + 0.03\% \times \text{span}}$	$\leq 0.38\text{ °C (0.683 °F) + 0.035\% \times \text{span}}$
Type B (31)		$\leq 0.5\text{ °C (0.9 °F)}$	$\leq 0.75\text{ °C (1.35 °F)}$	$\leq 1.0\text{ °C (1.8 °F)}$
Type C (32)	IEC 60584-1 / ASTM E988-96	$\leq 0.15\text{ °C (0.27 °F) + 0.018\% \times \text{span}}$	$\leq 0.24\text{ °C (0.43 °F) + 0.026\% \times \text{span}}$	$\leq 0.34\text{ °C (0.61 °F) + 0.027\% \times \text{span}}$
Type D (33)	ASTM E988-96	$\leq 0.21\text{ °C (0.38 °F) + 0.015\% \times \text{span}}$	$\leq 0.34\text{ °C (0.61 °F) + 0.02\% \times \text{span}}$	$\leq 0.47\text{ °C (0.85 °F) + 0.02\% \times \text{span}}$
Type E (34)	IEC 60584-1	$\leq 0.06\text{ °C (0.11 °F) + 0.018\% \times \text{span}}$	$\leq 0.09\text{ °C (0.162 °F) + 0.025\% \times \text{span}}$	$\leq 0.13\text{ °C (0.234 °F) + 0.026\% \times \text{span}}$
Type J (35)		$\leq 0.06\text{ °C (0.11 °F) + 0.019\% \times \text{span}}$	$\leq 0.1\text{ °C (0.18 °F) + 0.025\% \times \text{span}}$	$\leq 0.14\text{ °C (0.252 °F) + 0.027\% \times \text{span}}$
Type K (36)		$\leq 0.09\text{ °C (0.162 °F) + 0.017\% \times (MV + 150 °C (270 °F))}$	$\leq 0.14\text{ °C (0.252 °F) + 0.023\% \times \text{span}}$	$\leq 0.19\text{ °C (0.342 °F) + 0.024\% \times \text{span}}$
Type N (37)		$\leq 0.13\text{ °C (0.234 °F) + 0.015\% \times (MV + 150 °C (270 °F))}$	$\leq 0.2\text{ °C (0.36 °F) + 0.02\% \times \text{span}}$	$\leq 0.28\text{ °C (0.5 °F) + 0.02\% \times \text{span}}$
Type R (38)		$\leq 0.31\text{ °C (0.558 °F) + 0.011\% \times (MV + 50 °C (90 °F))}$	$\leq 0.5\text{ °C (0.9 °F) + 0.013\% \times \text{span}}$	$\leq 0.69\text{ °C (1.241 °F) + 0.011\% \times \text{span}}$
Type S (39)		$\leq 0.31\text{ °C (0.558 °F) + 0.011\% \times \text{span}}$		$\leq 0.7\text{ °C (1.259 °F) + 0.011\% \times \text{span}}$
Type T (40)		$\leq 0.09\text{ °C (0.162 °F) + 0.011\% \times \text{span}}$	$\leq 0.15\text{ °C (0.27 °F) + 0.013\% \times \text{span}}$	$\leq 0.2\text{ °C (0.36 °F) + 0.012\% \times \text{span}}$
Type L (41)	DIN 43710	$\leq 0.06\text{ °C (0.108 °F) + 0.017\% \times \text{span}}$	$\leq 0.1\text{ °C (0.18 °F) + 0.022\% \times \text{span}}$	$\leq 0.14\text{ °C (0.252 °F) + 0.022\% \times \text{span}}$
Type U (42)		$\leq 0.09\text{ °C (0.162 °F) + 0.013\% \times \text{span}}$	$\leq 0.14\text{ °C (0.252 °F) + 0.017\% \times \text{span}}$	$\leq 0.2\text{ °C (0.360 °F) + 0.015\% \times \text{span}}$
Type L (43)	GOST R8.8585-2001	$\leq 0.08\text{ °C (0.144 °F) + 0.015\% \times \text{span}}$	$\leq 0.12\text{ °C (0.216 °F) + 0.02\% \times \text{span}}$	$\leq 0.17\text{ °C (0.306 °F) + 0.02\% \times \text{span}}$
Voltage transmitter (mV)				
-20 to 100 mV		$\leq 2\mu\text{V} + 0.022\% \times \text{span}$	$\leq 3.5\mu\text{V} + 0.03\% \times \text{span}$	$\leq 4.7\mu\text{V} + 0.033\% \times \text{span}$

Influence of reference junction Pt100 DIN IEC 60751 Cl. B (internal cold junction with thermocouples TC)

12.5 Environment

Ambient temperature range ■ -40 to +85 °C (-40 to +185 °F), for hazardous areas see Ex documentation
 ■ SIL mode: -40 to +70 °C (-40 to +158 °F)

Storage temperature ■ Head transmitter: -50 to +100 °C (-58 to +212 °F)
 ■ DIN rail device: -40 to +100 °C (-40 to +212 °F)

Altitude Up to 4000 m (4374.5 yards) above mean sea level as per IEC 61010-1, CAN/CSA C22.2 No. 61010-1

Climate class	<ul style="list-style-type: none"> ■ Head transmitter: climate class C1 as per EN 60654-1 ■ DIN rail device: climate class B2 as per EN 60654-1
Humidity	<ul style="list-style-type: none"> ■ Condensation as per IEC 60 068-2-33: <ul style="list-style-type: none"> – Head transmitter permitted – DIN rail transmitter not permitted ■ Max. rel. humidity: 95% as per IEC 60068-2-30
Degree of protection	<ul style="list-style-type: none"> ■ Head transmitter with screw terminals: IP 00, with spring terminals: IP 30. In installed state, depends on the terminal head or field housing used. ■ When installing in field housing TA30A, TA30D or TA30H: IP 66/67 (NEMA Type 4x encl.) ■ DIN rail device: IP 20
Shock and vibration resistance	<p>Vibration resistance as per GL guideline, chapter 2, section 3B paragraph 9. Vibration and IEC 60068-2-27 or IEC 60068-2-6</p> <ul style="list-style-type: none"> ■ Head transmitter: 2 to 100 Hz at 4g (increased vibration stress) ■ DIN rail device: 2 to 100 Hz at 0.7g (general vibration stress) <p>Shock resistance as per KTA 3505 (section 5.8.4 Shock test)</p>
Electromagnetic compatibility (EMC)	<p>CE compliance</p> <p>Electromagnetic compatibility in accordance with all the relevant requirements of the IEC/EN 61326 series and NAMUR Recommendation EMC (NE21). For details, refer to the Declaration of Conformity. All tests were passed both with and without ongoing digital HART[®] communication.</p> <p>Maximum measured error <1% of measuring range.</p> <p>Interference immunity as per IEC/EN 61326 series, industrial requirements</p> <p>Interference emission as per IEC/EN 61326 series, Class B equipment</p>
Measuring category	<p>Measuring category II as per IEC 61010-1. The measuring category is provided for measuring on power circuits that are directly connected electrically with the low-voltage network.</p>
Degree of contamination	<p>Pollution degree 2 as per IEC 61010-1.</p>

12.6 Mechanical construction

Design, dimensions

Dimensions in mm (in)

Head transmitter

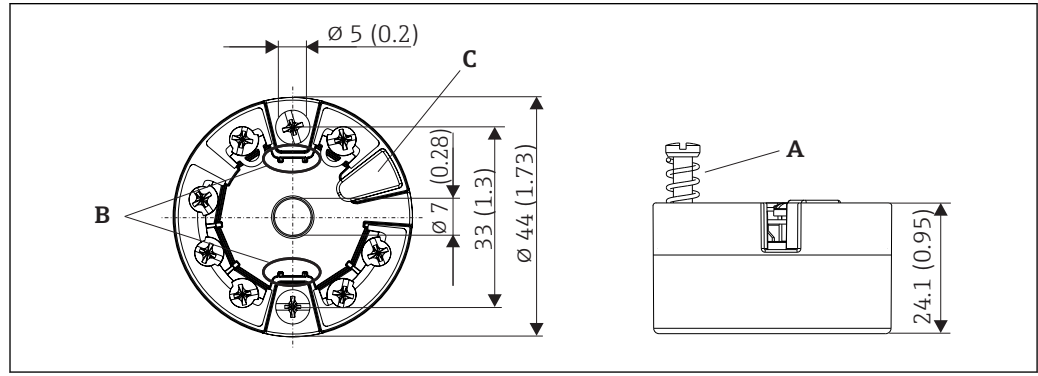

A0007301

16 Version with screw terminals

A Spring travel $L \geq 5$ mm (not for US - M4 securing screws)

B Mounting elements for attachable measured value display TID10

C Service interface for connecting measured value display or configuration tool

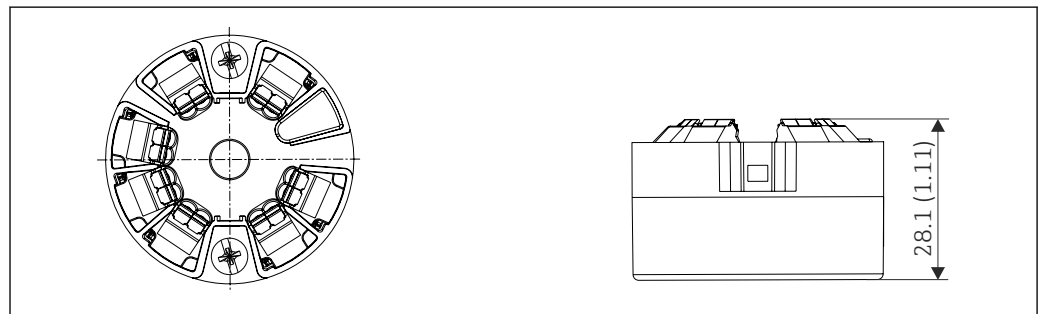

A0007672

17 Version with spring terminals. Dimensions are identical to the version with screw terminals, apart from housing height.

DIN rail device

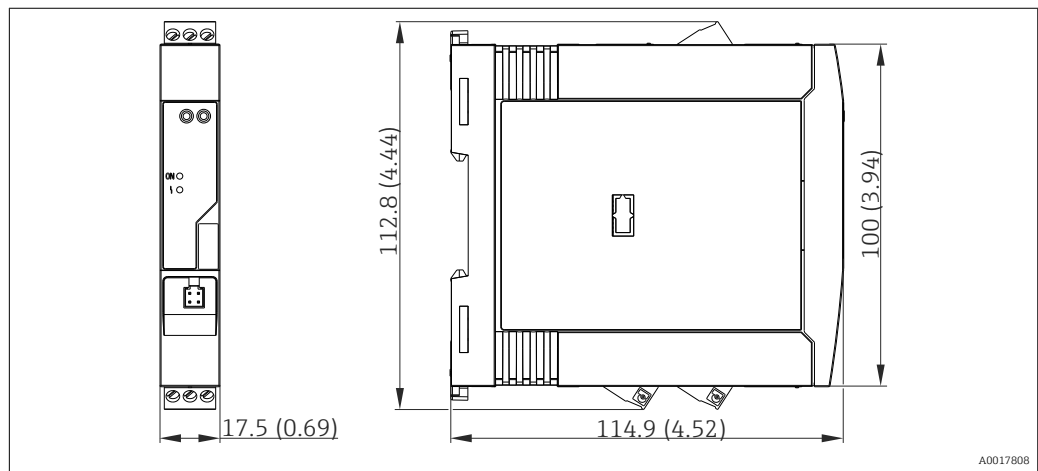

A0017808

Field housing

All field housings have an internal shape and size in accordance with DIN EN 50446, flat face. Cable glands in the diagrams: M20x1.5

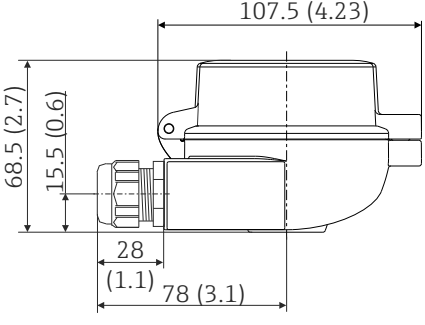
TA30A	Specification
 <p style="text-align: right; font-size: small;">A0009820</p>	<ul style="list-style-type: none"> ■ Two cable entries ■ Temperature: -50 to +150 °C (-58 to +302 °F) without cable gland ■ Material: aluminum, polyester powder coated ■ Seals: silicone ■ Cable entry glands: 1/2" NPT and M20x1.5 ■ Color of head: blue, RAL 5012 ■ Color of cap: gray, RAL 7035 ■ Weight: 330 g (11.64 oz)

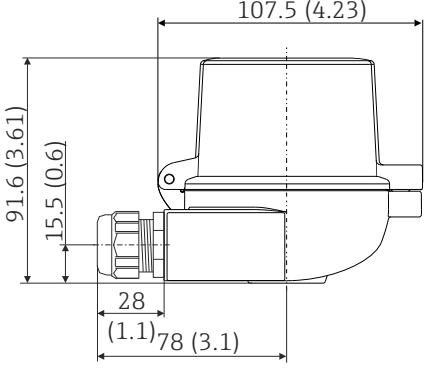
TA30A with display window in cover	Specification
 <p style="text-align: right; font-size: small;">A0009821</p>	<ul style="list-style-type: none"> ■ Two cable entries ■ Temperature: -50 to +150 °C (-58 to +302 °F) without cable gland ■ Material: aluminum, polyester powder coated ■ Seals: silicone ■ Cable entry glands: 1/2" NPT and M20x1.5 ■ Color of head: blue, RAL 5012 ■ Color of cap: gray, RAL 7035 ■ Weight: 420 g (14.81 oz)

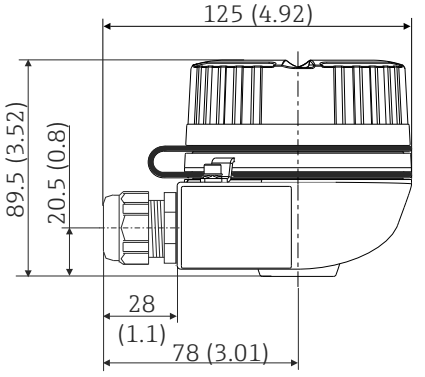
TA30H	Specification
 <p style="text-align: right; font-size: small;">A0009832</p>	<ul style="list-style-type: none"> ■ Flameproof (XP) version, explosion-protected, captive screw cap, with two cable entries ■ Temperature: -50 to +150 °C (-58 to +302 °F) for rubber seal without cable gland (observe max. permitted temperature of cable gland!) ■ Material: aluminum; polyester powder coated ■ Cable entry glands: 1/2" NPT, M20x1.5 ■ Color of head: blue, RAL 5012 ■ Color of cap: gray, RAL 7035 ■ Weight: approx. 640 g (22.6 oz)

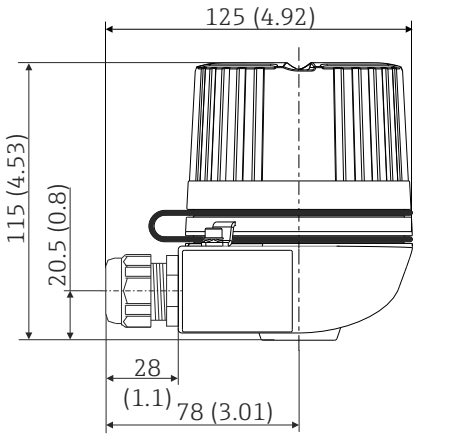
TA30H with display window in cover	Specification
	<ul style="list-style-type: none"> ■ Flameproof (XP) version, explosion-protected, captive screw cap, with two cable entries ■ Temperature: -50 to +150 °C (-58 to +302 °F) for rubber seal without cable gland (observe max. permitted temperature of cable gland!) ■ Material: aluminum; polyester powder coated ■ Cable entry glands: ½" NPT, M20x1.5 ■ Color of head: blue, RAL 5012 ■ Color of cap: gray, RAL 7035 ■ Weight: approx. 860 g (30.33 oz)

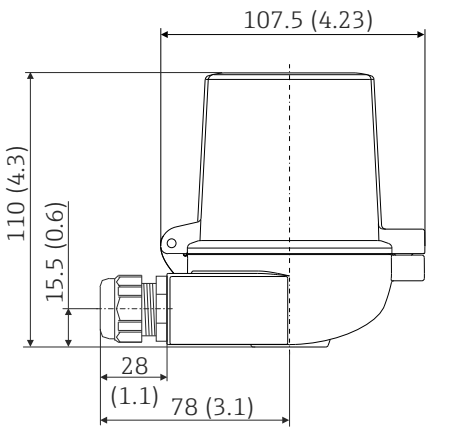
TA30D	Specification
	<ul style="list-style-type: none"> ■ 2 cable entries ■ Temperature: -50 to +150 °C (-58 to +302 °F) without cable gland ■ Material: aluminum, polyester powder coated ■ Seals: silicone ■ Cable entry glands: 1/2" NPT and M20x1.5 ■ Two head transmitters can be mounted. In the standard configuration one transmitter is mounted in the terminal head cover and an additional terminal block is installed directly on the insert. ■ Color of head: blue, RAL 5012 ■ Color of cap: gray, RAL 7035 ■ Weight: 390 g (13.75 oz)

Maximum ambient temperatures for cable glands	
Type	Temperature range
Polyamide cable gland ½" NPT, M20x1.5 (non-Ex)	-40 to +100 °C (-40 to 212 °F)
Polyamide cable gland M20x1.5 (for dust ignition-proof area)	-20 to +95 °C (-4 to 203 °F)
Brass cable gland ½" NPT, M20x1.5 (for dust ignition-proof area)	-20 to +130 °C (-4 to +266 °F)

Weight

- Head transmitter: approx. 40 to 50 g (1.4 to 1.8 oz)
- Field housing: see specifications
- DIN rail device: approx. 100 g (3.53 oz)

Materials

All the materials used are RoHS-compliant.

- Housing: polycarbonate (PC), corresponds to UL94, V-2 UL recognized
- Terminals:
 - Screw terminals: nickel-plated brass and gold-plated contacts
 - Spring terminals (head transmitter): tin-plated brass, contact springs 1.4310, 301 (AISI)
- Potting (head transmitter): WEVO PU 403 FP / FL

Field housing: see specifications

12.7 Certificates and approvals

CE mark	The product meets the requirements of the harmonized European standards. As such, it complies with the legal specifications of the EC directives. The manufacturer confirms successful testing of the product by affixing to it the CE-mark.
Ex approval	Information about currently available Ex versions (ATEX, FM, CSA, etc.) can be supplied by your E+H Sales Center on request. All explosion protection data are given in separate documentation which is available upon request.
Maritime guidelines	For the type approval certificates (GL, BV etc.) currently available, please contact your Endress+Hauser Sales Center for information. All data relating to shipbuilding can be found in separate type approval certificates which can be requested as needed.
UL approval	UL recognized component (see www.ul.com/database , search for Keyword "E225237")
CSA GP	CAN/CSA-C22.2 No. 61010-1, 2nd edition
Functional safety	<p>SIL 2/3 (hardware/software) certified to:</p> <ul style="list-style-type: none"> ■ IEC 61508-1:2010 (Management) ■ IEC 61508-2:2010 (Hardware) ■ IEC 61508-3:2010 (Software)
HART® certification	The temperature transmitter is registered by the HART® Communication Foundation. The device meets the requirements of the HART® Communication Protocol Specifications, Revision 7.0.
Examination certificate	In compliance with WELMEC 8.8: "Guide on the General and Administrative Aspects of the Voluntary System of Modular Evaluation of Measuring Instruments."

12.8 Documentation

- Functional Safety Manual 'iTEMP TMT82' (SD01172T/09/en)
- Supplementary ATEX documentation:
 - ATEX II 1G Ex ia IIC: XA00102T/09/a3
 - ATEX II2G Ex d IIC: XA01007T/09/a3 (transmitter in field housing)
 - ATEX II2(1)G Ex ia IIC: XA01012T/09/a3 (transmitter in field housing)

13 Operating menu and parameter description















 The following tables list all the parameters in the "Setup", "Diagnostics" and "Expert" operating menus. The page reference indicates where a description of the parameter can be found in the manual.





Depending on the parameter configuration, not all submenus and parameters are available in every device. Information on this can be found in the parameter description under "Prerequisite". The parameter groups for the Expert setup contain all the parameters of the "Setup" and "Diagnostics" operating menus, as well as other parameters that are solely reserved for experts.









This symbol  indicates how to navigate to the parameter using operating tools (e.g. FieldCare).

Configuration in the SIL mode differs from the standard mode and is described in the Functional Safety Manual.

 For more information please refer to the Functional Safety Manual SD01172T/09.

Setup →	Device tag	→  66
	Unit	→  66
	Sensor type 1	→  66
	Connection type 1	→  67
	2-wire compensation 1	→  67
	Reference junction 1	→  67
	RJ preset value 1	→  68
	Sensor type 2	→  66
	Connection type 2	→  67
	2-wire compensation 2	→  67
	Reference junction 2	→  67
	RJ preset value 2	→  68
	Assign current output (PV)	→  68
	Lower range value	→  69
	Meas. range end	→  69

Setup →	Extended Setup →	Enter access code	→  70
		Access status tooling	→  71
		Locking status	→  71
		Device temperature alarm	→  72

Setup →	Extended Setup →	Sensor →	Sensor offset 1	→  72
			Sensor offset 2	→  72
			Corrosion detection	→  72
			Drift/difference mode	→  73
			Drift/difference alarm category	→  73
			Drift/difference alarm delay	→  74
			Drift/difference set point	→  74
			Sensor switch set point	→  74

Setup →	Extended Setup →	Current output →	Output current	→ 75
			Measuring mode	→ 75
			Out of range category	→ 76
			Failure mode	→ 76
			Failure current	→ 76
			Current trimming 4 mA	→ 77
			Current trimming 20 mA	→ 77

Setup →	Extended Setup →	Display →	Display interval	→ 77
			Format display	→ 78
			Value 1 display	→ 78
			Decimal places 1	→ 79
			Value 2 display	→ 79
			Decimal places 2	→ 80
			Value 3 display	→ 80
			Decimal places 3	→ 81

Setup →	Extended Setup →	SIL →	SIL option	→ 81
			Operational state	→ 81
			Enter SIL checksum	→ 82
			SIL checksum	→ 82
			Timestamp SIL configuration	→ 83
			SIL startup mode	→ 82
			SIL HART mode	→ 83
			Force safe state	→ 84

Setup →	Extended Setup →	Administration →	Device reset	→ 84
			Define device write protection code	→ 84

Diagnosis →	Actual diagnostics	→ 86
	Remedy information	→ 86
	Previous diagnostics 1	→ 86
	Operating time	→ 86

Diagnosis →	Diagnostic list →	Actual diagnostics count	→ 87
		Actual diagnostics	→ 86
		Actual diag channel	→ 87

Diagnosis →	Event logbook →	Previous diagnostics n	→ 88
		Previous diag channel n	→ 88

Diagnosis →	Device information →	Device tag	→ 66
		Serial number	→ 89
		Firmware version	→ 89
		Device name	→ 89
		Order code	→ 89
		Configuration counter	→ 90

Diagnosis →	Measured values →	Sensor 1 value	→ 90
		Sensor 2 value	→ 90
		Device temperature	→ 90

Diagnosis →	Measured values →	Min/max values →	Sensor n min value	→ 90
			Sensor n max value	→ 91
			Reset sensor min/max values	→ 91
			Device temperature min.	→ 91
			Device temperature max.	→ 91
			Reset device temperature min/max	→ 92

Diagnosis →	Simulation →	Simulation current output	→ 92
		Value current output	→ 92

Expert →	Enter access code	→ 70
	Access status tooling	→ 71
	Locking status	→ 71

Expert →	System →	Unit	→ 66
		Damping	→ 94
		Alarm delay	→ 94
		Network frequency filter	→ 94
		Device temperature alarm	→ 95

Expert →	System →	Display →	Display interval	→ 77
			Format display	→ 78
			Value 1 display	→ 78
			Decimal places 1	→ 79
			Value 2 display	→ 79
			Decimal places 2	→ 80
			Value 3 display	→ 80
			Decimal places 3	→ 81

Expert →	System →	Administration →	Device reset	→ 84
			Define device write protection code	→ 84

Expert →	Sensor →	Sensor n ¹⁾ →		
			Sensor type n	→ 66
			Connection type n	→ 67
			2-wire compensation n	→ 67
			Reference junction n	→ 67
			RJ preset value	→ 68
			Sensor offset n	→ 72
			Sensor n lower limit	→ 95
			Sensor n upper limit	→ 95
			Sensor serial number	→ 95

1) n = number of sensor inputs (1 and 2)



Expert →	Sensor →	Sensor n →	Sensor trimming→	
			Sensor trimming	→ 96
			Sensor trimming lower value	→ 96
			Sensor trimming upper value	→ 97
			Sensor trimming min span	→ 97







Expert →	Sensor →	Sensor n ¹⁾ →	Linearization→	
			Sensor n lower limit	→ 95
			Sensor n upper limit	→ 95
			Call./v. Dusen coeff. R0, A, B, C	→ 98
			Polynomial coeff. R0, A, B	→ 99









1) n = number of sensor inputs (1 and 2)









Expert →	Sensor →	Diagnostic settings →		
			Corrosion detection	→ 72
			Drift/difference mode	→ 73
			Drift/difference alarm category	→ 73
			Drift/difference alarm delay	→ 74
			Drift/difference set point	→ 74
			Sensor switch set point	→ 74
			Calibration counter start	→ 99
			Calibration alarm category	→ 100
			Calibration counter start value	→ 100
			Calibration countdown	→ 100







Expert →	Output →		
		Output current	→ 75
		Measuring mode	→ 101
		Lower range value	→ 69
		Meas. range end	→ 69
		Out of range category	→ 76
		Failure mode	→ 76
		Failure current	→ 76





	Current trimming 4 mA	→  77
	Current trimming 20 mA	→  77

Expert →	Communication →	HART configuration →	Device tag	→  101
			HART short tag	→  101
			HART address	→  101
			No. of preambles	→  102
			Configuration changed	→  102
			Reset configuration changed flag	→  102

Expert →	Communication →	HART info →	Device type	→  102
			Device revision	→  103
			Manufacturer ID	→  103
			HART revision	→  103
			HART descriptor	→  103
			HART message	→  104
			Hardware revision	→  111
			RevSW	→  104
		HART date code	→  104	

Expert →	Communication →	HART output →	Assign current output (PV)	→  68
			PV	→  105
			Assign SV	→  105
			SV	→  105
			Assign TV	→  106
			TV	→  106
			Assign QV	→  106
		QV	→  106	

Expert →	Communication →	Burst configuration →	Burst mode	→  106
			Burst command	→  107
			Burst variables 0-3	→  107
			Burst trigger mode	→  108
			Burst trigger level	→  109
			Burst min period	→  109
			Burst max period	→  109

Expert →	Diagnosis →	Actual diagnostics	→  86
		Remedy information	→  86
		Previous diagnostics 1	→  86
		Operating time	→  86

Expert →	Diagnosis →	Diagnostic list →	Actual diagnostics count	→ 87
			Actual diagnostics	→ 86
			Actual diag channel	→ 87

Expert →	Diagnosis →	Event logbook →	Previous diagnostics n	→ 88
			Previous diag channel	→ 88

Expert →	Diagnosis →	Device information →	Device tag	→ 66
			Serial number	→ 89
			Firmware version	→ 89
			Device name	→ 89
			Order code	→ 89
			Extended order code	→ 110
			Extended order code 2	→ 110
			Extended order code 3	→ 110
			ENP version	→ 110
			Device revision	→ 103
			Manufacturer ID	→ 111
			Manufacturer	→ 111
			Hardware revision	→ 111
Configuration counter	→ 90			

Expert →	Diagnosis →	Measured values →	Sensor n value	→ 90
			Sensor n raw value	→ 111
			Device temperature	→ 90

Expert →	Diagnosis →	Measured values →	Min/max values →	Sensor n min value	→ 90
				Sensor n max value	→ 91
				Reset sensor min/max values	→ 91
				Device temperature min.	→ 91
				Device temperature max.	→ 91
				Reset device temperature min/max	→ 92



Expert →	Diagnosis →	Simulation →	Simulation current output	→ 92
			Value current output	→ 92

13.1 "Setup" menu

This menu contains all the parameters that are needed to configure the basic settings of the device. The transmitter can be put into operation with this limited parameter set.

 n = Stands for the number of sensor inputs (1 and 2)

Device tag





Navigation	 Setup → Device tag Diagnostics → Device information → Device tag Expert → Diagnostics → Device information → Device tag
Description	Use this function to enter a unique name for the measuring point so it can be identified quickly within the plant. The name is displayed in the header of the plug-in display. →  14,  25
User entry	Max. 32 characters, such as letters, numbers or special characters (e.g. @, %, /)
Factory setting	-none-

Unit

Navigation	 Setup → Unit Expert → System → Unit
Description	Use this function to select the engineering unit for all the measured values.
Options	<ul style="list-style-type: none"> ■ °C ■ °F ■ K ■ °R ■ Ohm ■ mV
Factory setting	°C

Sensor type n

Navigation	 Setup → Sensor type n Expert → Sensor → Sensor n → Sensor type n
-------------------	---

Description	Use this function to select the sensor type for the sensor input in question. <ul style="list-style-type: none"> ▪ Sensor type 1: settings for sensor input 1 ▪ Sensor type 2: settings for sensor input 2  Please observe the terminal assignment when connecting →  8,  17 the individual sensors. In the case of 2-channel operation, the possible connection options must also be observed.
Options	A list of all the possible sensor types is provided in the "Technical data" section. →  44
Factory setting	Sensor type 1: Pt100 IEC751 Sensor type 2: No sensor

Connection type n



Navigation	 Setup → Connection type n Expert → Sensor → Sensor n → Connection type n
Prerequisite	An RTD sensor must be specified as the sensor type.
Description	Use this function to select the connection type for the sensor.
Options	<ul style="list-style-type: none"> ▪ Sensor 1 (connection type 1): 2-wire, 3-wire, 4-wire ▪ Sensor 2 (connection type 2): 2-wire, 3-wire
Factory setting	<ul style="list-style-type: none"> ▪ Sensor 1 (connection type 1): 4-wire ▪ Sensor 2 (connection type 2): 2-wire

2-wire compensation n

Navigation	 Setup → 2-wire compensation n Expert → Sensor → Sensor n → 2-wire compensation n
Prerequisite	An RTD sensor with a 2-wire connection type must be specified as the sensor type.
Description	Use this function to specify the resistance value for two-wire compensation in RTDs.
User entry	0 to 30 Ohm
Factory setting	0

Reference junction n

Navigation	 Setup → Reference junction n Expert → Sensor → Sensor n → Reference junction n
-------------------	---



Prerequisite	A thermocouple (TC) sensor must be selected as the sensor type.
Description	Use this function to select reference junction measurement for temperature compensation of thermocouples (TC). <ul style="list-style-type: none">  If Preset value is selected, the compensation value is specified via the RJ preset value parameter. ▪ Temperature measured must be configured for channel 2 if Measured value sensor 2 is selected
Options	<ul style="list-style-type: none"> ▪ No compensation: no temperature compensation is used. ▪ Internal measurement: the internal reference junction temperature is used. ▪ Preset value: a fixed preset value is used. ▪ Measured value sensor 2: the measured value of sensor 2 is used. <p> It is not possible to selected the Measured value sensor 2 option for the Reference junction 2 parameter.</p>
Factory setting	Internal measurement

RJ preset value n

Navigation	 Setup → RJ preset value Expert → Sensor → Sensor n → RJ preset value
Prerequisite	The Preset value parameter must be set if the Reference junction n option is selected.
Description	Use this function to define the fixed preset value for temperature compensation.
User entry	-50 to +85 °C
Factory setting	0.00



Assign current output (PV)

Navigation	 Setup → Assign current output (PV) Expert → Communication → HART output → Assign current output (PV)
Description	Use this function to assign a measured variable to the primary HART® value (PV).



Options	<ul style="list-style-type: none"> ■ Sensor 1 (measured value) ■ Sensor 2 (measured value) ■ Device temperature ■ Average of the two measured values: $0.5 \times (SV1+SV2)$ ■ Difference between sensor 1 and sensor 2: $SV1-SV2$ ■ Sensor 1 (backup sensor 2): If sensor 1 fails, the value of sensor 2 automatically becomes the primary HART® value (PV); sensor 1 (OR sensor 2) ■ Sensor switching: If the value exceeds the configured threshold value T for sensor 1, the measured value of sensor 2 becomes the primary HART® value (PV). The system switches back to sensor 1 if the measured value of sensor 1 is at least 2 K below T: sensor 1 (sensor 2, if sensor 1 > T) ■ Average: $0.5 \times (SV1+SV2)$ with backup (measured value of sensor 1 or sensor 2 in the event of a sensor error in the other sensor) <p> The threshold value can be configured using the Sensor switch set point →  74 parameter . With temperature-dependent switching, it is possible to combine 2 sensors that offer advantages in different temperature ranges.</p>
----------------	--

Factory setting Sensor 1

Lower range value

Navigation	 Setup → Lower range value Expert → Output → Lower range value
Description	<p>Use this function to assign a measured value to the current value 4 mA.</p> <p> The limit value that can be set depends on the sensor type used in the Sensor type →  66 parameter and the measured variable assigned in the Assign current output (PV) parameter.</p>
User entry	Depends on the sensor type and the setting for "Assign current output (PV)".
Factory setting	0

Upper range value

Navigation	 Setup → Upper range value Expert → Output → Upper range value
Description	<p>Use this function to assign a measured value to the current value 20 mA.</p> <p> The limit value that can be set depends on the sensor type used in the Sensor type →  66 parameter and the measured variable assigned in the Assign current output (PV) parameter.</p>
User entry	Depends on the sensor type and the setting for "Assign current output (PV)".
Factory setting	100

13.1.1 "Extended Setup" submenu

Corrosion monitoring

Sensor connection cable corrosion can lead to false measured value readings. Therefore the unit offers the possibility of recognizing any corrosion before a measured value is affected. Corrosion monitoring is only possible for RTDs with a 4-wire connection and thermocouples.

Drift/difference mode

If two sensors are connected and the measured values differ by a specified value, a status signal is generated as a diagnostic event. The drift/difference monitoring function can be used to verify the correctness of the measured values and for mutual monitoring of the connected sensors. Drift/difference monitoring is enabled with the **Drift/difference mode** parameter. A distinction is made between two specific modes. If the **In band** option is selected ($ISV1-SV2I < \text{drift/difference set point}$), a status message is issued if the value drops below the set point, or if the value exceeds the set point if the **Out band (drift)** option is selected ($ISV1-SV2I > \text{drift/difference set point}$).

Procedure for configuring the drift/difference mode

1. Start
⇓
2. For drift/difference monitoring, select Out band for drift detection and In band for difference monitoring.
⇓
3. Set the alarm category for drift/difference monitoring to Out of specification (S) , Maintenance required (M) or Failure (F) as required.
⇓
4. Set the set point for drift/difference monitoring to the desired value.
⇓
5. End

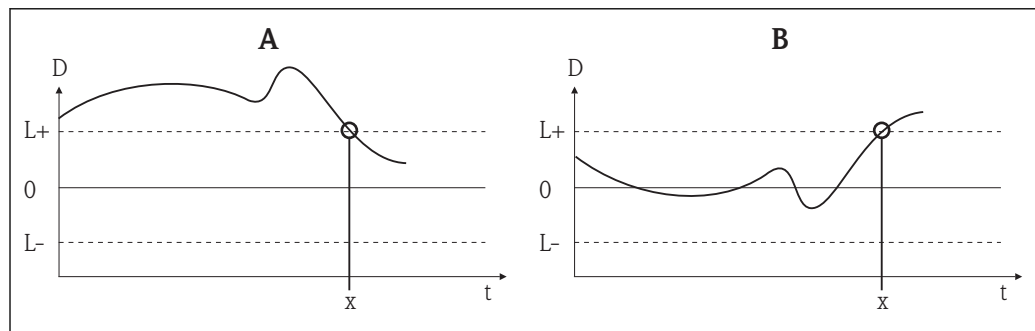



A0014782

18 Drift/difference mode

- A Value under range
- B Value over range
- D Drift
- L+, Upper (+) or lower (-) set point
- L-
- t Time
- x Diagnostics event, status signal is generated

Enter access code

Navigation	 Setup → Advanced setup → Enter access code Expert → Enter access code
Description	Use this function to enable the service parameters via the operating tool. If an incorrect access code is entered, the user retains his current access authorization.  If a value is entered that is not equal to the access code, the parameter is automatically set to 0 . The service parameters should only be modified by the service organization.
Additional information	Software device write protection is also switched on and off with this parameter. Software device write protection in conjunction with download from an operating tool with offline capabilities <ul style="list-style-type: none"> ■ Download, the device does not have a defined write protection code: The download is performed as normal. ■ Download, defined write protection code, device is not locked. <ul style="list-style-type: none"> – The Enter access code parameter (offline) contains the correct write protection code: the download is carried out, and the device is not locked following the download. The write protection code in the Enter access code parameter is set to 0. – The Enter access code parameter (offline) does not contain the correct write protection code: the download is carried out, and the device is locked following the download. The write protection code in the Enter access code parameter is reset to 0. ■ Download, defined write protection code, device is locked. <ul style="list-style-type: none"> – The Enter access code parameter (offline) contains the correct write protection code: the download is carried out, and the device is locked following the download. The write protection code in the Enter access code parameter is reset to 0. – The Enter access code parameter (offline) does not contain the correct write protection code: the download is not carried out. No values are changed in the device. The value of the Enter access code parameter (offline) also remains unchanged.
User entry	0 to 9999
Factory setting	0

Access status tooling

Navigation	 Setup → Advanced setup → Access status tooling Expert → Access status tooling
Description	Use this function to show access authorization to the parameters.
Additional information	If additional write protection is active, this restricts the current access authorization even further. The write protection status can be viewed via the Locking status parameter .
Options	<ul style="list-style-type: none"> ■ Operator ■ Service
Factory setting	Operator

Locking status

Navigation

 Setup → Advanced setup → Locking status
Expert → Locking status

Description

Use this function to view the device locking status. The DIP switch for hardware locking is fitted on the display module. When write protection is activated, write access to the parameters is disabled. →  26

Device temperature alarm

Navigation

 Setup → Advanced setup → Device temperature alarm

Description

Use this function to select the category (status signal) as to how the device reacts when the electronics temperature of the transmitter exceeds or falls below the limit value < -40 °C (-40 °F) or > +85 °C (+185 °F).

Options

- Off
- Out of specification (S)
- Failure (F)

Factory setting

Out of specification (S)

"Sensor" submenu

Sensor offset n

 n = Stands for the number of sensor inputs (1 and 2)

Navigation

 Setup → Advanced setup → Sensor → Sensor offset n
Expert → Sensor → Sensor n → Sensor offset n

Description

Use this function to set the zero point correction (offset) of the sensor measured value. The value indicated is added to the measured value.

User entry

-10.0...+10.0

Factory setting

0.0



Corrosion detection

Navigation

 Setup → Advanced setup → Sensor → Corrosion detection
Expert → Sensor → Diagnostic settings → Corrosion detection

Description	Use this function to select the category (status signal) which is displayed when corrosion is detected in the sensor connection cables.  Only possible for RTD sensors with 4-wire connection and thermocouples (TC).
Options	<ul style="list-style-type: none"> ■ Maintenance required (M) ■ Failure (F)
Factory setting	Maintenance required (M)



Drift/difference mode

Navigation	 Setup → Advanced setup → Sensor → Drift/difference mode Expert → Sensor → Diagnostic settings → Drift/difference mode
Description	Use this function to choose whether the device reacts to the drift/difference limit value being exceeded or undershot.  Can only be selected for 2-channel operation.
Additional information	<ul style="list-style-type: none"> ■ If the Out band (drift) option is selected, a status signal is displayed if the absolute value for the differential value exceeds the drift/difference set point ■ If the In band option is selected, a status signal is displayed if the absolute value for the differential value drops below the drift/difference set point.
Options	<ul style="list-style-type: none"> ■ Off ■ Out band (drift) ■ In band
Factory setting	Off

Drift/difference alarm category

Navigation	 Setup → Advanced setup → Sensor → Drift/difference alarm category Expert → Sensor → Diagnostic settings → Drift/difference alarm category
Prerequisite	The Drift/difference mode parameter must be activated with the Out band (drift) or In band option.
Description	Use this function to select the category (status signal) as to how the device reacts when a drift/difference is detected between sensor 1 and sensor 2.
Options	<ul style="list-style-type: none"> ■ Out of specification (S) ■ Maintenance required (M) ■ Failure (F)
Factory setting	Maintenance required (M)



Drift/difference alarm delay

Navigation	 Setup → Advanced setup → Sensor → Drift/difference alarm delay Expert → Sensor → Diagnostic settings → Drift/difference alarm delay
Prerequisite	The Drift/difference mode parameter must be activated with the Out band (drift) or In band option. →  73
Description	Alarm delay for drift detection monitoring.  Useful for example in the event of different thermal mass ratings for the sensors in conjunction with a high temperature gradient in the process.
User entry	0 to 255 s
Factory setting	0 s

Drift/difference set point

Navigation	 Setup → Advanced setup → Sensor → Drift/difference set point Expert → Sensor → Diagnostic settings → Drift/difference set point
Prerequisite	The Drift/difference mode parameter must be activated with the Out band (drift) or In band option.
Description	Use this function to configure the maximum permissible measured value deviation between sensor 1 and sensor 2 which results in drift/difference detection.
Options	0.1 to 999.0 K (0.18 to 1798.2 °F)
Factory setting	999.0

Sensor switch set point

Navigation	 Setup → Advanced setup → Sensor → Sensor switch set point Expert → Sensor → Diagnostic settings → Sensor switch set point
Description	Use this function to set the threshold value for sensor switching. →  69
Additional information	The threshold value is relevant if the sensor switching function is assigned to a HART® variable (PV, SV, TV, QV).
Options	Depends on the sensor types selected.
Factory setting	850 °C

"Current output" submenu**Adjustment of the analog output (4 and 20 mA current trimming)**

Current trimming is used to compensate the analog output (D/A conversion). Here, the output current of the transmitter must be adapted so that it suits the value expected at the higher-order system.

NOTICE

Current trimming does not affect the digital HART® value. This can cause the measured value shown on the plug-in display to differ from the value displayed in the higher-order system.

- ▶ The digital measured values can be adapted with the sensor trimming parameter in the menu Expert → Sensor → Sensor trimming.

Procedure

1. Start
⇓
2. Install an accurate amperemeter (more accurate than the transmitter) in the current loop.
⇓
3. Switch on current output simulation and set the simulation value to 4 mA.
⇓
4. Measure the loop current with the amperemeter and make a note of the value.
⇓
5. Set the simulation value to 20 mA.
⇓
6. Measure the loop current with the amperemeter and make a note of the value.
⇓
7. Enter the current values determined as adjustment values in the Current trimming 4 mA / 20 mA parameters
⇓
8. End

Output current**Navigation**

 Setup → Advanced setup → Current output → Output current
Expert → Output → Output current

Description

Use this function to view the calculated output current in mA.

Measuring mode**Navigation**

 Setup → Advanced setup → Current output → Measuring mode
Expert → Output → Measuring mode

Description

Enables the inversion of the output signal.

Additional information	<ul style="list-style-type: none"> ▪ Standard The output current increases with increasing temperatures ▪ inverted The output current decreases with increasing temperatures
Options	<ul style="list-style-type: none"> ▪ Standard ▪ inverted
Factory setting	Standard

Out of range category

Navigation	 Setup → Advanced setup → Current output → Out of range category Expert → Output → Out of range category
Description	Use this function to select the category (status signal) as to how the device reacts when the value is outside the set measuring range.
Options	<ul style="list-style-type: none"> ▪ Out of specification (S) ▪ Maintenance required (M) ▪ Failure (F)
Factory setting	Maintenance required (M)

Failure mode



Navigation	 Setup → Advanced setup → Current output → Failure mode Expert → Output → Failure mode
Description	Use this function to select the signal on alarm level of the current output in the event of an error.
Additional information	If Max. is selected, the signal on alarm level is specified using the Failure current parameter.
Options	<ul style="list-style-type: none"> ▪ Min. ▪ Max.
Factory setting	Max.

Failure current



Navigation	 Setup → Advanced setup → Current output → Failure current Expert → Output → Failure current
Prerequisite	The Max. option is enabled in the Failure mode parameter.

Description	Use this function to set the value the current output adopts in an alarm condition.
User entry	21.5 to 23.0 mA
Factory setting	22.5

Current trimming 4 mA

Navigation	 Setup → Advanced setup → Current output → Current trimming 4 mA Expert → Output → Current trimming 4 mA
Description	Use this function to set the correction value for the current output at the start of the measuring range at 4 mA. →  75
User entry	3.85 to 4.15 mA
Factory setting	4 mA

Current trimming 20 mA

Navigation	 Setup → Advanced setup → Current output → Current trimming 20 mA Expert → Output → Current trimming 20 mA
Description	Use this function to set the correction value for the current output at the end of the measuring range at 20 mA. →  75
User entry	19.850 to 20.15 mA
Factory setting	20.000 mA

"Display" submenu

The settings for displaying the measured value on the optional plug-in display (only for head transmitter) are made in the "Display" menu.

 These settings do not have any effect on the output values of the transmitter. They are only used to configure how information is shown on the display.

Display interval

Navigation	 Setup → Advanced setup → Display → Display interval Expert → System → Display → Display interval
-------------------	---

Description	<p>Use this function to set the length of time the measured values are displayed if the values alternate on the display. The display only alternates between values if more than one measured value is defined.</p> <ul style="list-style-type: none"> i <ul style="list-style-type: none"> ▪ The Value 1 display - Value 3 display parameters are used to specify what measured values are shown on the display → 78. ▪ The display format of the displayed measured values is specified using the Format display parameter.
User input	4 to 20 s
Factory settings	4 s

Format display

Navigation	<ul style="list-style-type: none"> ☰ Setup → Advanced setup → Display → Format display Expert → System → Display → Format display
-------------------	---

Description Use this function to select how the measured value is shown on the local display. The display format **Measured value** or **Measured value with bar graph** can be configured.

- Options:**
- Value only
 - Value + Bargraph

Factory settings Value only

Additional information *Value only*

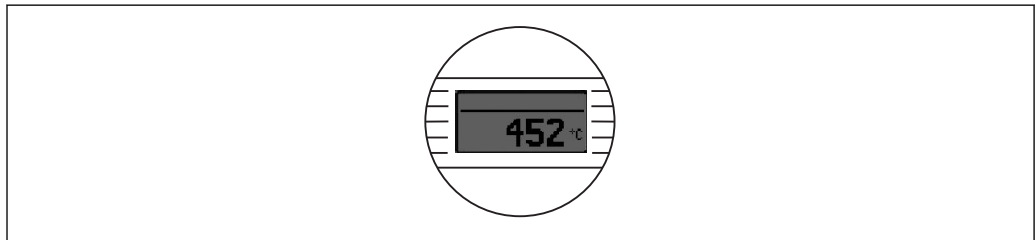

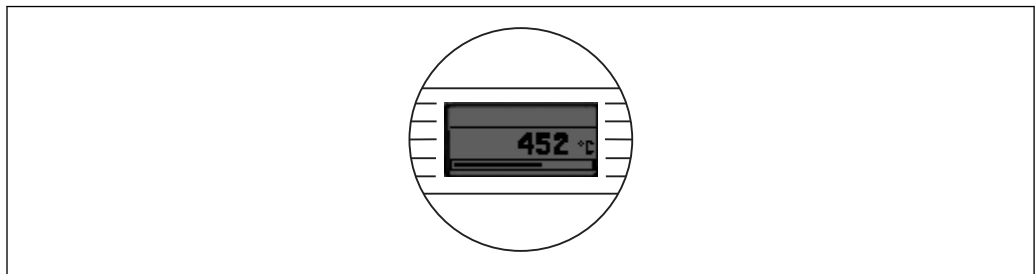

A0014564

Value + Bargraph





A0014563



Value 1 display

Navigation	 Setup → Advanced setup → Display → Value 1 display Expert → System → Display → Value 1 display
Description	Use this function to select one of the measured values to be shown on the local display.  The Format display parameter is used to specify how the measured values are displayed →  78.
Options:	<ul style="list-style-type: none"> ■ Process value ■ Sensor 1 ■ Sensor 2 ■ Output current ■ Percent of range ■ Device temperature
Factory settings	Process value

Decimal places 1

Navigation	 Setup → Advanced setup → Display → Decimal places 1 Expert → System → Display → Decimal places 1
Prerequisite	A measured value is specified in the Value 1 display parameter →  78.
Description	Use this function to select the number of decimal places displayed for the display value. This setting does not affect the accuracy of the device for measuring or calculating the value.  If Automatic is selected, the maximum possible number of decimal places is always shown on the display.
Options:	<ul style="list-style-type: none"> ■ x ■ x.x ■ x.xx ■ x.xxx ■ x.xxxx ■ Automatic
Factory settings	Automatic

Value 2 display

Navigation	 Setup → Advanced setup → Display → Value 2 display Expert → System → Display → Value 2 display
Description	Use this function to select one of the measured values to be shown on the local display.  The Format display parameter is used to specify how the measured values are displayed .

- Options:**
- Off
 - Process value
 - Sensor 1
 - Sensor 2
 - Output current
 - Percent of range
 - Device temperature

Factory settings Off

Decimal places 2

Navigation  Setup → Advanced setup → Display → Decimal places 2
Expert → System → Display → Decimal places 2

Prerequisite A measured value is specified in the **Value 2 display** parameter.

Description Use this function to select the number of decimal places displayed for the display value. This setting does not affect the accuracy of the device for measuring or calculating the value.

 If **Automatic** is selected, the maximum possible number of decimal places is always shown on the display.

- Options:**
- x
 - x.x
 - x.xx
 - x.xxx
 - x.xxxx
 - Automatic

Factory settings Automatic

Value 3 display

Navigation  Setup → Advanced setup → Display → Value 3 display
Expert → System → Display → Value 3 display

Description Use this function to select one of the measured values to be shown on the local display.

 The **Format display** parameter is used to specify how the measured values are displayed.

- Options:**
- Off
 - Process value
 - Sensor 1
 - Sensor 2
 - Output current
 - Percent of range
 - Device temperature

Factory settings Off

Decimal places 3

Navigation  Setup → Advanced setup → Display → Decimal places 3
Expert → System → Display → Decimal places 3

Prerequisite A measured value is specified in the **Value 3 display** parameter.

Description Use this function to select the number of decimal places displayed for the display value. This setting does not affect the accuracy of the device for measuring or calculating the value.

 If **Automatic** is selected, the maximum possible number of decimal places is always shown on the display.

Options:

- x
- x.x
- x.xx
- x.xxx
- x.xxxx
- Automatic

Factory settings Automatic

"SIL" submenu

 This menu only appears if the device was ordered with the 'SIL mode' option. The **SIL option** parameter indicates whether the device can be operated in the SIL mode. To enable the SIL mode for the device, menu-guided operation for **Enable SIL** must be performed.

 A detailed description is provided in the Functional Safety Manual **SD01172T**.

SIL option

Navigation  Setup → Advanced setup → SIL → SIL option

Description Indicates whether the device has been ordered with SIL certification. SIL certificate of the device

 The SIL option is required to operate the device in the SIL mode.

Options

- No
- Yes

Factory setting No

Operational state

Navigation  Setup → Advanced setup → SIL → Operational state

Description Displays the device operational state in the SIL mode.

- Display**
- Checking SIL option
 - Startup normal mode
 - Wait for checksum
 - Self diagnostic
 - Normal mode
 - Download active
 - SIL mode active
 - Safe para start
 - Safe param running
 - Save parameter values
 - Parameter check
 - Reboot pending
 - Reset checksum
 - Safe state - Active
 - Download verification
 - Upload active
 - Safe state - Passive
 - Safe state - Panic

 If the device is restarted with the setting "**SIL startup mode → Not active**", "**Wait for checksum**" appears in this parameter. The SIL checksum must be entered manually here.

Factory setting Checking SIL option

Enter SIL checksum

Navigation  Setup → Advanced setup → SIL → Enter SIL checksum

Description Use this function to enter the SIL checksum during safe parameterization and startup in conjunction with the parameter setting "**SIL startup mode → Not active**".

 If the parameter setting is "**SIL startup modus → Active**" and the value '0' is entered, automatic startup is aborted and the SIL settings are discarded.

User entry 0 ... 65535



Factory setting 0

SIL checksum



Navigation  Setup → Advanced setup → SIL → SIL checksum

Description	Use this function to display the SIL checksum entered.  The SIL checksum displayed can be used to check the device configuration. If 2 devices have identical configurations, the SIL checksum is also identical. This can make for easy device replacement because if the checksum is the same, the device configuration is guaranteed to be identical too.
--------------------	---

Timestamp SIL configuration

Navigation	 Setup → Advanced setup → SIL → Timestamp SIL configuration
Description	Use this function to enter the date and time when safe parameterization has been completed and the SIL checksum has been calculated.  The date and time must be entered manually. This information is not generated automatically by the device.
User entry	DD.MM.YYYY hh:mm
Factory setting	0



SIL startup mode

Navigation	 Setup → Advanced setup → SIL → SIL startup mode
Description	Setting for repeated automatic device startup in the SIL mode, e.g. after a power-cycle.  The " Not active " setting requires the user to enter the SIL checksum manually in order to be able to start the device again in SIL mode.
Options	<ul style="list-style-type: none"> ■ Not active ■ Active
Factory setting	Not active

SIL HART mode

Navigation	 Setup → Advanced setup → SIL → SIL HART mode
Description	Setting for HART® communication in the SIL mode. The " HART not active " setting disables HART® communication in the SIL mode (only 4 to 20 mA communication is active).
Options	<ul style="list-style-type: none"> ■ HART not active ■ HART active
Factory setting	HART active

Force safe state

Navigation	 Setup → Advanced setup → SIL → Force safe state
Prerequisite	The Operational state parameter displays SIL mode active .
Description	During SIL proof testing this parameter is used to test error detection and the safe state of the device.  A detailed description of SIL proof testing is provided in the Functional Safety Manual SD01172T/09 .
Options	<ul style="list-style-type: none"> ■ On ■ Off
Factory setting	Off



"Administration" submenu

Device reset

Navigation	 Setup → Advanced setup → Administration → Device reset Expert → System → Device reset
Description	Use this function to reset the device configuration - either entirely or in part - to a defined state.
Options	<ul style="list-style-type: none"> ■ Not active No action is executed and the user exits the parameter. ■ To factory defaults All the parameters are reset to the factory setting. ■ To delivery settings All the parameters are reset to the order configuration. The order configuration can differ from the factory setting if customer-specific parameter values were defined when the device was ordered. ■ Restart device The device is restarted but the device configuration remains unchanged.
Factory setting	Not active

Define device write protection code

Navigation	 Setup → Advanced setup → Administration → Define device write protection code Expert → System → Define device write protection code
-------------------	--

Description	<p>Sets a write protection code for the device.</p> <p> If the code is programmed into the device firmware it is saved in the device and the operating tool displays the value 0 so that the defined write protection code is not openly displayed for viewing.</p>
User entry	0 to 9999
Factory setting	0
Additional information	<ul style="list-style-type: none">▪ Activating device write protection: To do so, enter a value in the Enter access code parameter that does not correspond to the write protection code defined here.▪ Deactivating device write protection: If device write protection is activated, enter the defined write protection code in the Enter access code parameter.▪ Once the device has been reset to the factory setting or the order configuration, the defined write protection code is no longer valid. The code adopts the factory setting (= 0).▪ Hardware write protection (DIP switches) is active:<ul style="list-style-type: none">– Hardware write protection has priority over the software write protection described here.– No value can be entered in the Enter access code parameter. The parameter is a read only parameter.– Device write protection via software can only be defined and activated if hardware write protection via the DIP switches is disabled. →  26 <p> If the write protection code has been forgotten, it can be deleted or overwritten by the service organization.</p>

13.2 "Diagnostics" menu

All the information that describes the device, the device status and the process conditions can be found in this group.

Actual diagnostics 1

Navigation	 Diagnostics → Actual diagnostics Expert → Diagnostics → Actual diagnostics 1
Description	Use this function to display the current diagnostics message. If two or more messages occur simultaneously, the message with the highest priority is shown on the display.
Display	Symbol for event behavior and diagnostic event.
Additional information	Example for display format: F261-Electronics modules

Remedy information

Navigation	 Diagnostics → Remedy information Expert → Diagnostics → Remedy information
Description	Use this function to display the remedial action to be taken for the current diagnostics message.

Previous diagnostics 1

Navigation	 Diagnostics → Previous diagnostics 1 Expert → Diagnostics → Previous diagnostics 1
Description	Use this function to display the last diagnostics message with the highest priority.
Display	Symbol for event behavior and diagnostic event.
Additional information	Example for display format: F261-Electronics modules

Operating time

Navigation	 Diagnostics → Operating time Expert → Diagnostics → Operating time
Description	Use this function to display the length of time the device has been in operation.

Display Hours (h)

13.2.1 "Diagnose list" submenu

Up to 3 diagnostic messages currently pending are displayed in this submenu. If more than 3 messages are pending, the messages with the highest priority are shown on the display. Information on diagnostics measures in the device and an overview of all the diagnostics messages →  37.

Actual diagnostics count

Navigation  Diagnostics → Diagnostics list → Actual diagnostics count
Expert → Diagnostics → Diagnostics list → Actual diagnostics count

Description Use this function to display the number of diagnosis messages currently pending in the device.

Actual diagnostics

Navigation  Diagnostics → Diagnostics list → Actual diagnostics
Expert → Diagnostics → Diagnostics list → Actual diagnostics

Description Use this function to display the current diagnostics messages with the highest priority to the third-highest priority.

Display Symbol for event behavior and diagnostic event.

Additional information Example for display format:
F261-Electronics modules

Actual diag channel

Navigation  Diagnostics → Diagnostics list → Actual diag channel
Expert → Diagnostics → Diagnostics list → Actual diag channel

Description Use this function to display the sensor input to which the diagnostics message refers.

Display

- Sensor 1
- Sensor 2
- - - - - -

13.2.2 "Event logbook" submenu

Previous diagnostics n

 n = Number of diagnostics messages (n = 1 to 5)

Navigation

 Diagnostics → Diagnostics list → Previous diagnostics n
 Expert → Diagnostics → Diagnostics list → Previous diagnostics n

Description

Use this function to display the diagnostics messages that occurred in the past. The last 5 messages are listed in chronological order.

Display

Symbol for event behavior and diagnostic event.

Additional information

Example for display format:
 F261-Electronics modules

Previous diag channel

Navigation

 Diagnostics → Diagnostics list → Previous diag channel
 Expert → Diagnostics → Diagnostics list → Previous diag channel

Description

Use this function to display the possible sensor input to which the diagnostics message refers.

Display

- Sensor 1
- Sensor 2
- -----

13.2.3 "Device information" submenu

Device tag

Navigation

 Setup → Device tag
 Diagnostics → Device information → Device tag
 Expert → Diagnostics → Device information → Device tag

Description

Use this function to enter a unique name for the measuring point so it can be identified quickly within the plant. The name is displayed in the header of the plug-in display.
 →  25

User entry

Max. 32 characters, such as letters, numbers or special characters (e.g. @, %, /)

Factory setting

-none-

Serial number

Navigation

 Diagnostics → Device information → Serial number
Expert → Diagnostics → Device information → Serial number

Description

Use this function to display the serial number of the device. It can also be found on the nameplate.

**Uses of the serial number**

- To identify the measuring device quickly, e.g. when contacting Endress+Hauser.
- To obtain specific information on the measuring device using the Device Viewer: www.endress.com/deviceviewer

Display

Max. 11-digit character string comprising letters and numbers

Firmware version

Navigation

 Diagnostics → Device information → Firmware version
Expert → Diagnostics → Device information → Firmware version

Description

Use this function to view the device firmware version installed.

Display

Max. 6-digit character string in the format xx.yy.zz

Device name

Navigation

 Diagnostics → Device info. → Device name
Expert → Diagnostics → Device information → Device name

Description

Displays the device name. It can also be found on the nameplate.

Order code

Navigation

 Diagnostics → Device information → Order code
Expert → Diagnostics → Device information → Order code

Description

Use this function to display the order code of the device. It can also be found on the nameplate. The order code is generated from the extended order code, which defines all the device features of the product structure. In contrast, the device features cannot be read directly from the order code.

**Uses of the order code**

- To order an identical spare device.
- To identify the device quickly and easily, e.g. when contacting the manufacturer.

Configuration counter

Navigation

 Diagnostics → Device info. → Configuration counter
Expert → Diagnostics → Device info. → Configuration counter

Description

Use this function to display the counter reading for changes to device parameters.

 Static parameters, whose values change during optimization or configuration, cause this parameter to increment by 1. This support parameter version management. If several parameters change, e. g. due to loading of parameters from FieldCare, etc. in the device, the counter can show a higher value. The counter cannot be reset and is also not reset to the default value when the device is reset. If the counter overflows, (16 bit), it starts again at 1.

13.2.4 "Measured values" submenu

Sensor n value

 n = Stands for the number of sensor inputs (1 and 2)

Navigation

 Diagnostics → Measured values → Sensor n value
Expert → Diagnostics → Measured values → Sensor n value

Description

Use this function to display the current measured value at the sensor input.

Device temperature

Navigation

 Diagnostics → Measured values → Device temperature
Expert → Diagnostics → Measured values → Device temperature

Description

Use this function to display the current electronics temperature.

"Min/max values" submenu

Sensor n min value

 n = Stands for the number of sensor inputs (1 and 2)

Navigation

 Diagnostics → Measured values → Min/max values → Sensor n min value
Expert → Diagnostics → Measured values → Min/max values → Sensor n min value

Description

Use this function to display the minimum temperature measured in the past at sensor input 1 or 2 (peakhold indicator).

Sensor n max value

 n = Stands for the number of sensor inputs (1 and 2)

Navigation

 Diagnostics → Measured values → Min/max values → Sensor n max value
Expert → Diagnostics → Measured values → Min/max values → Sensor n max. value

Description

Use this function to display the maximum temperature measured in the past at sensor input 1 or 2 (peakhold indicator).

Reset sensor min/max values

Navigation

 Diagnostics → Measured values → Min/max values → Reset sensor min/max values
Expert → Diagnostics → Measured values → Min/max values → Reset sensor min/max values

Description

Reset the peakhold indicators for the minimum and maximum temperatures measured at the sensor inputs.

Options

- No
- Yes

Factory setting

No

Device temperature min.

Navigation

 Diagnostics → Measured values → Min/max values → Device temperature min.
Expert → Diagnostics → Measured values → Min/max values → Device temperature min.

Description

Use this function to display the minimum electronics temperature measured in the past (peakhold indicator).

Device temperature max.

Navigation

 Diagnostics → Measured values → Min/max values → Device temperature max.
Expert → Diagnostics → Measured values → Min/max values → Device temperature max.

Description

Use this function to display the maximum electronics temperature measured in the past (peakhold indicator).

Reset device temp. min/max values

Navigation	 Diagnostics → Measured values → Min/max values → Reset device temp. min/max values Expert → Diagnostics → Measured values → Min/max values → Reset device temp. min/max values
Description	Reset the peakhold indicators for the minimum and maximum electronic temperatures measured.
Options	<ul style="list-style-type: none"> ■ No ■ Yes
Factory setting	No

13.2.5 "Simulation" submenu

Simulation current output



Navigation	 Diagnostics → Simulation → Simulation current output Expert → Diagnostics → Simulation → Simulation current output
Description	Use this function to switch simulation of the current output on and off. The display alternates between the measured value and a diagnostics message of the "function check" category (C) while simulation is in progress.
Display	Measured value display ↔ C491 (simulation current output)
Options	<ul style="list-style-type: none"> ■ Off ■ On
Factory setting	Off
Additional information	The simulation value is defined in the Value current output parameter.

Value current output

Navigation	 Diagnostics → Simulation → Value current output Expert → Diagnostics → Simulation → Value current output
Additional information	The Simulation current output parameter must be set to On .
Description	Use this function to set a current value for the simulation. In this way, users can verify the correct adjustment of the current output and the correct function of downstream switching units.

User entry	3.59 to 23.0 mA
Factory setting	3.59 mA

13.3 "Expert" menu

 The parameter groups for the Expert setup contain all the parameters of the "Setup" and "Diagnostics" operating menus, as well as other parameters that are solely reserved for experts. Descriptions of the additional parameters can be found in this section. All the fundamental parameter settings for transmitter commissioning and diagnostic evaluation are described in the "Setup menu" →  66 and "Diagnostics menu" →  86 sections.

13.3.1 "System" submenu

Damping

Navigation	 Expert → System → Damping
Description	Use this function to set the time constant for current output damping.
User entry	0 to 120 s
Factory setting	0.00 s
Additional information	The current output reacts with an exponential delay to fluctuations in the measured value. The time constant of this delay is specified by this parameter. If a low time constant is entered, the current output follows the measured value quickly. On the other hand, if a high time constant is entered, the current output reaction is delayed.

Alarm delay

Navigation	 Expert → System → Alarm delay
Description	Use this function to set the delay time during which a diagnostics signal is suppressed before it is output.
User entry	0 to 5 s
Factory setting	2 s

Mains filter

Navigation	 Expert → System → Mains filter
Description	Use this function to select the mains filter for A/D conversion.
Options	<ul style="list-style-type: none"> ■ 50 Hz ■ 60 Hz
Factory setting	50 Hz

Device temperature alarm →  72

Navigation  Expert → System → Device temperature alarm

"Display" submenu

→  77

"Administration" submenu

→  84

13.3.2 "Sensor" submenu

"Sensor 1/2" submenu

 n = Stands for the number of sensor inputs (1 and 2)

Sensor n lower limit

Navigation  Expert → Sensor → Sensor n → Sensor n lower limit

Description Displays the minimum physical full scale value.

Sensor n upper limit

Navigation  Expert → Sensor → Sensor n → Sensor n upper limit

Description Displays the maximum physical full scale value.

Sensor serial number

Navigation  Expert → Sensor → Sensor n → Serial no. sensor

Description Use this function to enter the serial number of the connected sensor.

User entry String with up to 12 characters consisting of numbers and/or text

Factory setting "" (no text)

"Sensor trimming" submenu

Sensor error adjustment (sensor trimming)

Sensor trimming is used to adapt the actual sensor signal to the linearization of the selected sensor type stored in the transmitter. Compared to sensor transmitter matching, sensor trimming only takes place at the start and end value and does not achieve the same level of accuracy.

 Sensor trimming does not adapt the measuring range. It is used to adapt the sensor signal to the linearization stored in the transmitter.

Procedure

1. Start
⇓
2. Set the Sensor trimming parameter to the Customer-specific setting.
⇓
3. Using a water/oil bath, bring the sensor connected to the transmitter to a known and stable temperature. A temperature which is close to the set start of the measuring range is recommended.
⇓
4. Enter the reference temperature for the value at the start of the measuring range for the Sensor trimming lower value parameter. Based on the difference between the specified reference temperature and the temperature actually measured at the input, the transmitter internally calculates a correction factor which is now used to linearize the input signal.
⇓
5. Using a water/oil bath, bring the sensor connected to the transmitter to a known and stable temperature close to the set end of the measuring range.
⇓
6. Enter the reference temperature for the value at the end of the measuring range for the Sensor trimming upper value parameter.
⇓
7. End

Sensor trimming

Navigation

 Expert → Sensor → Sensor n → Sensor trimming → Sensor trimming

Description

Use this function to select the linearization method to be used for the connected sensor.

 The original linearization can be restored by resetting this parameter to the **Factory setting** option.

Options

- Factory setting
- Customer-specific

Factory setting

Factory setting

Sensor trimming lower value

Navigation

 Expert → Sensor → Sensor n → Sensor trimming → Sensor trimming lower value

Prerequisite	The Customer-specific option is enabled in the Sensor trimming parameter → 96 .
Description	Lower point for linear characteristic calibration (this affects offset and slope).
User entry	Depends on the selected sensor type and the assignment of the current output (PV).
Factory setting	-200 °C

Sensor trimming upper value

Navigation	 Expert → Sensor → Sensor n → Sensor trimming → Sensor trimming upper value
Prerequisite	The Customer-specific option is enabled in the Sensor trimming parameter.
Description	Upper point for linear characteristic calibration (this affects offset and slope).
User entry	Depends on the selected sensor type and the assignment of the current output (PV).
Factory setting	850 °C

Sensor trimming min span

Navigation	 Expert → Sensor → Sensor n → Sensor trimming → Sensor trimming min span
Prerequisite	The Customer-specific option is enabled in the Sensor trimming parameter.
Description	Use this function to view the minimum possible span between the sensor trimming upper and lower value.

"Linearization" submenu

Procedure for configuring a linearization using Callendar/Van Dusen coefficients from a calibration certificate.

1. Start
⇓
2. Assign current output (PV) = set sensor 1 (measured value)
⇓
3. Select unit (°C).
⇓
4. Select the sensor type (linearization type) "RTD platinum (Callendar/Van Dusen)".
⇓
5. Select connection mode e.g. 3-wire.
⇓
6. Set the lower and upper sensor limits.
⇓

7. Enter the four coefficients A, B, C and R0.
⇓
8. If special linearization is also used for a second sensor, repeat steps 2 to 6.
⇓
9. End

Sensor n lower limit

Navigation	 Expert → Sensor → Sensor n → Linearization → Sensor n lower limit
Prerequisite	The RTD platinum, RTD poly nickel or RTD copper polynomial option is enabled in the Sensor type parameter.
Description	Use this function to set the lower calculation limit for special sensor linearization.
User entry	Depends on the sensor type selected.
Factory setting	-200 °C

Sensor n upper limit

Navigation	 Expert → Sensor → Sensor n → Linearization → Sensor n upper limit
Prerequisite	The RTD platinum, RTD poly nickel or RTD copper polynomial option is enabled in the Sensor type parameter.
Description	Use this function to set the upper calculation limit for special sensor linearization.
User entry	Depends on the sensor type selected.
Factory setting	850 °C

Call./v. Dusen coeff. R0

Navigation	 Expert → Sensor → Sensor n → Linearization → Call./v. Dusen coeff. R0
Prerequisite	The RTD platinum (Callendar/Van Duse) option is enabled in the Sensor type parameter.
Description	Use this function to set the R0 Value only for linearization with the Callendar/Van Dusen polynomial.
User entry	40.000 to 1 050.000
Factory setting	100.000 Ohm

Call./v. Dusen coeff. A, B and C

Navigation	 Expert → Sensor → Sensor n → Linearization → Call./v. Dusen coeff. A, B, C
Prerequisite	The RTD platinum (Callendar/Van Duse) option is enabled in the Sensor type parameter.
Description	Use this function to set the coefficients for sensor linearization based on the Callendar/Van Dusen method.
Factory setting	<ul style="list-style-type: none"> ■ A: 3.910000e-003 ■ B: -5.780000e-007 ■ C: -4.180000e-012

Polynomial coeff. R0



Navigation	 Expert → Sensor → Sensor n → Linearization → Polynomial coeff. R0
Prerequisite	The RTD poly nickel or RTD copper polynomial option is enabled in the Sensor type parameter.
Description	Use this function to set the R0 Value only for linearization of nickel/copper sensors.
User entry	40.000 to 1 050.000 Ohm
Factory setting	100.00 Ohm

Polynomial coeff. A, B

Navigation	 Expert → Sensor → Sensor n → Linearization → Polynomial coeff. A, B
Prerequisite	The RTD poly nickel or RTD copper polynomial option is enabled in the Sensor type parameter.
Description	Use this function to set the coefficients for sensor linearization of copper/nickel resistance thermometers.
Factory setting	Polynomial coeff. A = 5.49630e-003 Polynomial coeff. B = 6.75560e-006

"Diagnostic settings" submenu

Calibration counter start

Navigation	 Expert → Sensor → Diagnostic settings → Calibration counter start
Description	Option to control the calibration counter. <ul style="list-style-type: none">  The countdown duration (in days) is specified with the Calibration counter start value parameter. ▪ The status signal issued when the limit value is reached is defined with the Calibration alarm category parameter.
Options	<ul style="list-style-type: none"> ▪ Off: Stops the calibration counter ▪ On: Starts the calibration counter ▪ Reset + run: Resets to the set start value and starts the calibration counter
Factory setting	Off



Calibration alarm category

Navigation	 Expert → Sensor → Diagnostic settings → Calibration alarm category
Description	Use this function to select the category (status signal) as to how the device reacts when the set calibration countdown expires.
Options	<ul style="list-style-type: none"> ▪ Maintenance required (M) ▪ Failure (F)
Factory setting	Maintenance required (M)

Calibration counter start value

Navigation	 Expert → Sensor → Diagnostic settings → Calibration counter start value
Description	Use this function to set the start value for the calibration counter.
User entry	0 to 365 d (days)
Factory setting	365

Calibration countdown

Navigation	 Expert → Sensor → Diagnostic settings → Calibration countdown
Description	Use this function to view the time remaining until the next calibration. <ul style="list-style-type: none">  Calibration countdown only runs when the device is active. Example: If the calibration counter is set to 365 days on January 1, 2011 and no electricity is supplied to the device for 100 days, the alarm for the calibration appears on April 10, 2012.

13.3.3 "Output" submenu

Measuring mode

Navigation	 Expert → Output → Measuring mode
Description	Enables the inversion of the output signal.
Additional information	<ul style="list-style-type: none"> ▪ Standard The output current increases with increasing temperatures ▪ inverted The output current decreases with increasing temperatures
Options	<ul style="list-style-type: none"> ▪ Standard ▪ inverted
Factory setting	Standard

13.3.4 "Communication" submenu

"HART configuration" submenu

Device tag → 88

Navigation	 Diagnostics → Device information → Device tag Expert → Communication → HART configuration → Device tag
-------------------	---

HART short tag

Navigation	 Expert → Communication → HART configuration → HART short tag
Description	Use this function to define a short tag for the measuring point.
User entry	Up to 8 alphanumeric characters (letters, numbers and special characters)
Factory setting	SHORTTAG

HART address

Navigation	 Expert → Communication → HART configuration → HART address
Description	Use this function to define the HART address of the device.

User entry	0 ... 63
Factory setting	0
Additional information	The measured value can only be transmitted via the current value if the address is set to "0". The current is fixed at 4.0 mA for all other addresses (Multidrop mode).

No. of preambles

Navigation	 Expert → Communication → HART configuration → No. of preambles
Description	Use this function to define the number of preambles in the HART telegram
User entry	2 ... 20
Factory setting	5

Configuration changed

Navigation	 Expert → Communication → HART configuration → Configuration changed
Description	Indicates whether the configuration of the device has been changed by a master (primary or secondary).

Reset configuration changed flag

Navigation	 Expert → Communication → HART configuration → Reset configuration changed flag
Description	The Configuration changed information is reset by a master (primary or secondary).

"HART info" submenu

Device type

Navigation	 Expert → Communication → HART info → Device type
Description	Use this function to view the device type with which the device is registered with the HART FieldComm Group. The device type is specified by the manufacturer. It is needed to assign the appropriate device description file (DD) to the device.
Display	2-digit hexadecimal number

HART message

Navigation	 Expert → Communication → HART info → HART message
Description	Use this function to define a HART message which is sent via the HART protocol when requested by the master.
User entry	Up to 32 alphanumeric characters (letters, numbers and special characters)
Factory setting	The device name

Hardware revision

Navigation	 Expert → Diagnostics → Device information → Hardware revision Expert → Communication → HART info → Hardware revision
Description	Use this function to display the hardware revision of the device.

SWRev

Navigation	 Expert → Communication → HART info → SWRev
Description	Use this function to display the software revision of the device.

HART date code

Navigation	 Expert → Communication → HART info → HART date code
Description	Use this function to define date information for individual use.
User entry	Date in the format year-month-day (YYYY-MM-DD)
Factory setting	2010-01-01

"HART output" submenu

Assign current output (PV)



Navigation	 Expert → Communication → HART output → Assign current output (PV)
-------------------	---

Description	Use this function to assign a measured variable to the primary HART value (PV).
Options	<ul style="list-style-type: none"> ■ Sensor 1 (measured value) ■ Sensor 2 (measured value) ■ Device temperature ■ Average of the two measured values: $0.5 \times (SV1+SV2)$ ■ Difference between sensor 1 and sensor 2: $SV1-SV2$ ■ Sensor 1 (backup sensor 2): If sensor 1 fails, the value of sensor 2 automatically becomes the primary HART® value (PV): sensor 1 (OR sensor 2) ■ Sensor switching: If the value exceeds the configured threshold value T for sensor 1, the measured value of sensor 2 becomes the primary HART® value (PV). The system switches back to sensor 1 if the measured value of sensor 1 is at least 2 K below T: sensor 1 (sensor 2, if sensor 1 > T) ■ Average: $0.5 \times (SV1+SV2)$ with backup (measured value of sensor 1 or sensor 2 in the event of a sensor error in the other sensor) <p> The threshold value can be set with the Sensor switching limit value parameter. With temperature-dependent switching, it is possible to combine 2 sensors that offer advantages in different temperature ranges.</p>
Factory setting	Sensor 1

PV

Navigation	 Expert → Communication → HART output → PV
Description	Use this function to display the primary HART value



Assign SV

Navigation	 Expert → Communication → HART output → Assign SV
Description	Use this function to assign a measured variable to the secondary HART value (SV).
Options	See Assign current output (PV) parameter, →  104
Factory setting	Device temperature

SV

Navigation	 Expert → Communication → HART output → SV
Description	Use this function to display the secondary HART value



Assign TV

Navigation	 Expert → Communication → HART output → Assign TV
Description	Use this function to assign a measured variable to the tertiary HART value (TV).
Options	See Assign current output (PV) parameter, →  104
Factory setting	Sensor 1

TV

Navigation	 Expert → Communication → HART output → TV
Description	Use this function to display the tertiary HART value

Assign QV

Navigation	 Expert → Communication → HART output → Assign QV
Description	Use this function to assign a measured variable to the quaternary (fourth) HART value (QV).
Options	See Assign current output (PV) parameter, →  104
Factory setting	Sensor 1

QV

Navigation	 Expert → Communication → HART output → QV
Description	Use this function to display the quaternary HART value

"Burst configuration" submenu

 Up to 3 burst modes can be configured.

Burst mode

Navigation	 Expert → Communication → Burst configuration → Burst mode
Description	Activation of the HART burst mode for burst message X. Message 1 has the highest priority, message 2 the second-highest priority, etc.
Options	<ul style="list-style-type: none"> ▪ Off The device only sends data to the bus at the request of a HART master ▪ On The device regularly sends data to the bus without being requested to do so.
Factory setting	Off

Burst command

Navigation	 Expert → Communication → Burst configuration → Burst command
Prerequisite	This parameter can only be selected if the Burst mode option is enabled.
Description	Use this function to select the command whose answer is sent to the HART master in the activated burst mode.
Options	<ul style="list-style-type: none"> ▪ Command 1 Read out the primary variable ▪ Command 2 Read out the current and the main measured value as a percentage ▪ Command 3 Read out the dynamic HART variables and the current ▪ Command 9 Read out the dynamic HART variables including the related status ▪ Command 33 Read out the dynamic HART variables including the related unit
Factory setting	Command 2
Additional information	Commands 1, 2, 3 and 9 are universal HART commands. Command 33 is a "Common-Practice" HART command. More details on this are provided in the HART specifications.



Burst variable n

 n = Number of burst variables (0 to 3)

Navigation	 Expert → Communication → Burst configuration → Burst variable n
Prerequisite	This parameter can only be selected if the Burst mode option is enabled.

Description

Use this function to assign a measured variable to slots 0 to 3.

 This assignment is **only** relevant for the burst mode. The measured variables are assigned to the 4 HART variables (PV, SV, TV, QV) in the **HART output** →  104 menu.

Options

- Sensor 1 (measured value)
- Sensor 2 (measured value)
- Device temperature
- Average of the two measured values: $0.5 \times (SV1+SV2)$
- Difference between sensor 1 and sensor 2: $SV1-SV2$
- Sensor 1 (backup sensor 2): If sensor 1 fails, the value of sensor 2 automatically becomes the primary HART® value (PV): sensor 1 (OR sensor 2)
- Sensor switching: If the value exceeds the configured threshold value T for sensor 1, the measured value of sensor 2 becomes the primary HART® value (PV). The system switches back to sensor 1 if the measured value of sensor 1 is at least 2 K below T: sensor 1 (sensor 2, if sensor 1 > T)

 The threshold value can be set with the **Sensor switching limit value** parameter. With temperature-dependent switching, it is possible to combine 2 sensors that offer advantages in different temperature ranges.

Average: $0.5 \times (SV1+SV2)$ with backup (measured value of sensor 1 or sensor 2 in the event of a sensor error in the other sensor)

Factory setting

- Burst variable slot 0: sensor 1
- Burst variable slot 1: device temperature
- Burst variable slot 2: sensor 1
- Burst variable slot 3: sensor 1

Burst trigger mode

Navigation

 Expert → Communication → Burst configuration → Burst trigger mode

Prerequisite

This parameter can only be selected if the **Burst mode** option is enabled.

Description

Use this function to select the event that triggers burst message X.

-  **Continuous:**
The message is triggered in a time-controlled manner, at least observing the time interval defined in the "Burst min period X" parameter.
- **Window:**
The message is triggered if the specified measured value has changed by the value defined in the "Burst trigger level X" parameter.
 - **Rising:**
The message is triggered if the specified measured value exceeds the value in the "Burst trigger level X" parameter.
 - **Falling:**
The message is triggered if the specified measured value falls below the value in the "Burst trigger level X" parameter.
 - **On change:**
The message is triggered if a measured value of the message changes.

Options	<ul style="list-style-type: none"> ■ Continuous ■ Window ■ Rising ■ Falling ■ On change
----------------	--

Factory setting	Continuous
------------------------	------------

Burst trigger level

Navigation	 Expert → Communication → Burst configuration → Burst trigger level
-------------------	--

Prerequisite	This parameter can only be selected if the Burst mode option is enabled.
---------------------	---

Description	Use this function to enter the value which, together with the trigger mode, determines the time of burst message 1. This value determines the time of the message.
--------------------	--

User entry	-1.0e+20 to +1.0e+20
-------------------	----------------------

Factory setting	-1.0e+20
------------------------	----------

Burst min period

Navigation	 Expert → Communication → Burst configuration → Burst min period
-------------------	---

Prerequisite	This parameter can only be selected if the Burst mode option is enabled.
---------------------	---

Description	Use this function to enter the minimum time span between two burst commands of burst message X. The value is entered in the unit 1/32 milliseconds.
--------------------	---

User entry	500 to [value entered for the maximum interval in the Burst max period parameter] in whole numbers
-------------------	---

Factory setting	1000
------------------------	------

Burst max period

Navigation	 Expert → Communication → Burst configuration → Burst max period
-------------------	---

Prerequisite	This parameter can only be selected if the Burst mode option is enabled.
---------------------	---

Description	Use this function to enter the maximum time span between two burst commands of burst message X. The value is entered in the unit 1/32 milliseconds.
--------------------	---

User entry	[Value entered for the minimum interval in the Burst min period parameter] to 3600000 in whole numbers
-------------------	---

Factory setting 2000

13.3.5 "Diagnostics" submenu

"Diagnose list" submenu

Detailed description →  87

"Event logbook" submenu

Detailed description →  88

"Device information" submenu

Extended order code 1-3

Navigation  Expert → Diagnostics → Device information → Extended order code 1-3

Description Use this function to display the first, second and/or third part of the extended order code. On account of length restrictions, the extended order code is split into a maximum of 3 parameters. The extended order code indicates the version of all the features of the product structure for the device and thus uniquely identifies the device. It can also be found on the nameplate.



Uses of the extended order code

- To order an identical spare device.
- To check the ordered device features using the delivery note.

ENP version

Navigation  Expert → Diagnostics → Device information → ENP version

Description Displays the version of the electronic nameplate.

Display 6-digit number in the format xx.yy.zz

Device revision

Navigation  Expert → Diagnostics → Device information → Device revision
Expert → Communication → HART info → Device revision

Description Use this function to view the device revision with which the device is registered with the HART FieldComm Group. It is needed to assign the appropriate device description file (DD) to the device.

Display 2-digit hexadecimal number

Manufacturer ID →  103

Navigation

Expert → Communication → HART info → Manufacturer ID
 Expert → Diagnostics → Device information → Manufacturer ID

Manufacturer

Navigation

Expert → Diagnostics → Device information → Manufacturer

Description

Displays the manufacturer name.

Hardware revision

Navigation

Expert → Diagnostics → Device information → Hardware revision
 Expert → Communication → HART info → Hardware revision

Description

Use this function to display the hardware revision of the device.

"Measured values" submenu

Sensor n raw value



n = Stands for the number of sensor inputs (1 and 2)

Navigation

Expert → Diagnostics → Measured values → Sensor n raw value

Description

Use this function to display the non-linearized mV/Ohm value at the specific sensor input.

"Min/max values" submenu

Detailed description →  90

"Simulation" submenu

Detailed description →  92

Index

- 0 ... 9**
- 2-wire compensation (parameter) 67
- A**
- Access status tooling (parameter) 71
 - Accessories
 - Communication-specific 34
 - Device-specific 34
 - System components 35
 - Actual diag channel 87
 - Actual diagnostics 87
 - Actual diagnostics 1 86
 - Actual diagnostics count 87
 - Administration (submenu) 84, 95
 - Advanced setup (submenu) 70
 - Alarm delay (parameter) 94
 - Assign current output (PV) (parameter) 68, 104
 - Assign QV (parameter) 106
 - Assign SV (parameter) 105
 - Assign TV (parameter) 106
- B**
- Burst command (parameter) 107
 - Burst configuration (submenu) 106
 - Burst max period (parameter) 109
 - Burst min period (parameter) 109
 - Burst mode (parameter) 106
 - Burst trigger level (parameter) 109
 - Burst trigger mode (parameter) 108
 - Burst variables (parameter) 107
- C**
- Cable specification 19
 - Calibration alarm category (parameter) 100
 - Calibration countdown 100
 - Calibration counter start (parameter) 99
 - Calibration counter start value (parameter) 100
 - Call./v. Dusen coeff. A, B and C (parameter) 99
 - Call./v. Dusen coeff. RO (parameter) 98
 - CE mark 59
 - Communication (submenu) 101
 - Comparison point (parameter) 67
 - Configuration changed (parameter) 102
 - Configuration counter 90
 - Connection combinations 18
 - Connection type (parameter) 67
 - Corrosion detection (parameter) 72
 - Current output (submenu) 75
 - Current trimming 4 mA (parameter) 77
 - Current trimming 20 mA (parameter) 77
- D**
- Damping (parameter) 94
 - Decimal places 1 (parameter) 79
 - Decimal places 2 (parameter) 80
 - Decimal places 3 (parameter) 81
 - Define device write protection code (parameter) 84
 - Designated use 7
 - Device info (submenu) 88, 110
 - Device name 89
 - Device reset (parameter) 84
 - Device revision 103, 110
 - Device tag (parameter) 66, 88, 101
 - Device temperature 90
 - Device temperature alarm (parameter) 72, 95
 - Device temperature max. 91
 - Device temperature min. 91
 - Device type 102
 - Diagnose list (submenu) 87
 - Diagnostic settings (menu) 99
 - Diagnostics (menu) 86
 - Diagnostics (submenu) 110
 - Diagnostics events
 - Diagnostic behavior 39
 - Overview 40
 - Status signals 39
 - Display (menu) 77
 - Display (submenu) 95
 - Display interval (parameter) 77
 - Drift/difference alarm category (parameter) 73
 - Drift/difference alarm delay 74
 - Drift/difference mode (parameter) 73
 - Drift/difference set point (parameter) 74
- E**
- ENP version 110
 - Enter access code (parameter) 70
 - Enter SIL checksum (parameter) 82
 - Event logbook (submenu) 88
 - Expert (Menu) 94
 - Extended order code 110
- F**
- Failure current (parameter) 76
 - Failure mode (parameter) 76
 - FieldCare
 - Function scope 27
 - User interface 28
 - Firmware version 89
 - Force safe state (parameter) 84
 - Format display (parameter) 78
- H**
- Hardware revision 104, 111
 - HART address (parameter) 101
 - HART configuration (submenu) 101
 - HART date code (parameter) 104
 - HART descriptor (parameter) 103
 - HART info (submenu) 102
 - HART message (parameter) 104
 - HART output (submenu) 104
 - HART revision 103
 - HART short tag (parameter) 101

- HART® protocol
 - Device variables 30
 - Operating tools 30
 - Version data for the device 30
- L**
- Linearization (submenu) 97
- Locking status 71
- Lower range value (parameter) 69
- M**
- Mains filter (parameter) 94
- Manufacturer 111
- Manufacturer ID (parameter) 103, 111
- Measured values (submenu) 90, 111
- Measuring mode (parameter) 75, 101
- Min/max values (submenu) 90
- Mounting location
 - DIN rail (DIN rail clip) 11
 - Field housing 11
 - Terminal head, flat face as per DIN 43729 11
- N**
- Nameplate 8
- No. of preambles (parameter) 102
- O**
- Operating time 86
- Operation options
 - Local operation 22
 - Operating tool 22
 - Overview 22
- Operational state (parameter) 81
- Order code 89
- Out of range category (parameter) 76
- Output (submenu) 101
- Output current 75
- P**
- Polynomial coeff. A, B (parameter) 99
- Polynomial coeff. R0 (parameter) 99
- Previous diag channel 88
- Previous diagnostics 88
- Previous diagnostics 1 86
- PV 105
- Q**
- QV 106
- R**
- Remedy information 86
- Reset configuration changed flag (parameter) 102
- Reset device temp. min/max values (parameter) 92
- Reset sensor min/max values (parameter) 91
- Return 43
- RJ preset value (parameter) 68
- S**
- Sensor (submenu) 72, 95
- Sensor 1/2 (submenu) 95
- Sensor lower limit 95
- Sensor lower limit (parameter) 98
- Sensor max. value 91
- Sensor min value 90
- Sensor offset (parameter) 72
- Sensor raw value 111
- Sensor switch set point (parameter) 74
- Sensor trimming (parameter) 96
- Sensor trimming (submenu) 96
- Sensor trimming lower value (parameter) 96
- Sensor trimming min span 97
- Sensor trimming upper value (parameter) 97
- Sensor type (parameter) 66
- Sensor upper limit 95
- Sensor upper limit (parameter) 98
- Sensor value 90
- Serial no. sensor (parameter) 95
- Serial number 89
- Setup (menu) 66
- SIL (submenu) 81
- SIL checksum (parameter) 82
- SIL HART mode (parameter) 83
- SIL option (parameter) 81
- SIL startup mode (parameter) 83
- Simulation (submenu) 92
- Simulation current output (parameter) 92
- Solid wire 19
- Structure of the operating menu 23
- SV 105
- SWRev 104
- System (submenu) 94
- System components 35
- T**
- Terminal assignment 17
- Timestamp SIL configuration (parameter) 83
- Troubleshooting
 - Application error with RTD sensor connection 38
 - Application error with TC sensor connection 38
 - Checking the display 37
 - General errors 37
- TV 106
- U**
- UL approval 59
- Unit (parameter) 66
- Upper range value (parameter) 69
- V**
- Value 1 display (parameter) 78
- Value 2 display (parameter) 79
- Value 3 display (parameter) 80
- Value current output (parameter) 92
- W**
- Wire without wire end ferrule 19

www.addresses.endress.com
