

Special Documentation

Liquiphant M/S with electronic insert FEL58 + Nivotester FTL325N

Functional Safety Manual

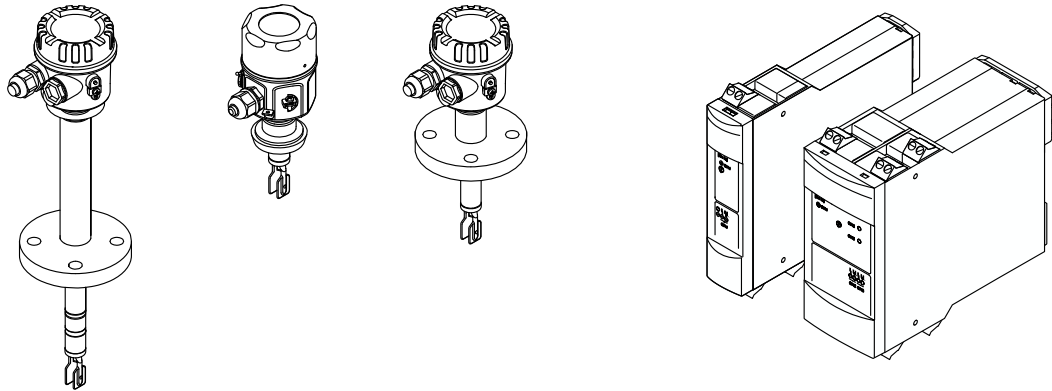

Point level measuring system

Table of contents

Declaration of conformity	3
General	4
Other safety-related characteristic values	5
Useful lifetime of electrical components	13
Certificate	14
Document information	15
Document function	15
Symbols used	15
Supplementary device documentation	16
Permitted devices types	17
SIL label on the nameplate	18
Safety function	19
Definition of the safety function	19
Restrictions for use in safety-related applications	19
Use in safety instrumented systems	22
Device behavior during operation	22
Device configuration for safety-related applications	22
Proof-testing	26
Life cycle	38
Requirements for personnel	38
Installation	38
Operation	38
Maintenance	38
Repair	38
Modification	39
Decommissioning	39
Appendix	40
Structure of the measuring system	40
Commissioning or proof test report	42
Further information	44
Version history	44

Declaration of conformity

SIL_00071_03.15

Endress+Hauser 
People for Process Automation

Declaration of Conformity

Functional Safety according to IEC 61508:2010
Supplement 1 / NE130 Form B.1

Endress+Hauser GmbH+Co. KG, Hauptstraße 1, 79689 Maulburg

being the manufacturer, declares that the product stated below

Liquiphant M/S with electronic insert FEL58 (+ Nivotester FTL325N)

is suitable for the use in safety-instrumented systems up to SIL2 according to IEC 61508:2010.

In safety instrumented systems according IEC 61508 and IEC 61511, the instructions of the Safety Manual have to be followed.

Maulburg, 17-June-2016
Endress+Hauser GmbH+Co. KG

i. V.



Dr. Arno Götz
Dept. Manager Product Safety
Research & Development



i. V.



Dr. Dietmar Frühauf
Dept. Manager Level Switches
Research & Development

1/2

A0028074

- Version IV (→  9)
Two Liquiphant devices with a 3-channel Nivotester, switching contacts are switched in series
- Version V (→  11)
Three Liquiphant devices with a 3-channel Nivotester, all channels are used, evaluation is performed in a safety-related PLC, for example
- Version VI (→  13)
Three Liquiphant devices with a 3-channel Nivotester, only channel 1 has a SIL-specific monitoring function. Channels 2 and 3 are used for level control of the same level (e.g. Δs). This level control may not then be considered as a safety measure as part of functional safety according to EN 61508.

NOTICE

Measuring another, independent level (e.g. in a second tank)



- ▶ The remaining channels may not be used for other levels.

Other safety-related characteristic values

-  Please note the following for the tables below:
 - A common cause factor $\beta = 10\%$ has been assumed in the calculations indicated below.
 - For multi-channel systems, the PFD_{avg} values already contain common cause failures for the specific wiring scheme.
 - The PFD_{avg} values only apply to the particular wiring scheme for which the values have been calculated. They are not a suitable basis for making calculations for other wiring schemes. The use of NC contacts instead of NO contacts, in particular, is not permitted for operation according to SIL specifications.
 - The wiring scheme indicates the number of devices and the circuitry of the level relay contacts (open when required (demand mode)).
 - If there are several devices in a wiring scheme, all the devices have the same settings shown.
 - The tables show safety-related values and wiring options for the measuring system.
 - FIT = Failure in Time, 1 FIT = 10^{-9} 1/h.

Specific functional safety parameters:

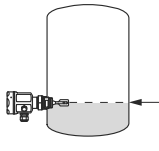
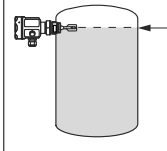
Version I: Liquiphant M/S

Characteristics as per IEC 61508	Value	
Safety function	MIN	MAX
Example		
Wiring scheme	 <p><i>A Other safety equipment e.g. actuator/safety-related PLC</i></p>	
SIL	2	
HFT	0	
Device type	B	
Mode of operation	Low demand mode	
SFF	69 %	75 %
MTTR	8 h	
$\lambda_{sd}^{1)}$	66 FIT	78 FIT
λ_{su}	85 FIT	87 FIT
λ_{dd}	13 FIT	12 FIT
λ_{du}	73 FIT	59 FIT
PFD_{avg} for $T_1 = 1$ year	3.18×10^{-4}	2.59×10^{-4}
MTBF	482 years	
Diagnostic test interval ²⁾	≤ 60 s	
Fault reaction time ³⁾	≤ 3 s	
System reaction time ⁴⁾	1 s (covered > free)	0.5 s (free > covered)
PTC test sequence A ⁵⁾	93 %	
PTC test sequence B ⁶⁾	2 %	
PTC test sequence C ⁷⁾	-	93 %

- 1) This value takes into account failure types relevant to the function of the electronic components according to Siemens SN29500.
- 2) During this time, all diagnostic functions are executed at least once.
- 3) Time between error detection and error response.
- 4) Step response time as per DIN EN 61298-2.
- 5) Proof test coverage when the level is approached, or when the sensor is removed and the tines are immersed in a medium of similar density and viscosity.
- 6) Proof test coverage when simulation is performed on the Nivotester or electronic insert FEL58 by activating the test button.
- 7) Proof test coverage when checking the switch point under reference operating conditions.

Version II: Liquiphant M/S; 1-channel Nivotester FTL325N

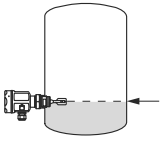
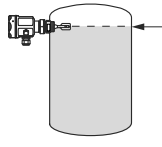
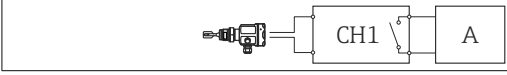
Characteristics as per IEC 61508	Value	
Safety function	MIN	MAX
Example		
Wiring scheme	 <p><i>A Other safety equipment e.g. actuator/safety-related PLC</i></p>	
SIL	2	
HFT	0	
Device type	B	
Mode of operation	Low demand mode	
SFF	85 %	87 %
MTTR	8 h	
$\lambda_{sd}^{1)}$	66 FIT	78 FIT
$\lambda_{su}^{1)}$	554 FIT	
$\lambda_{dd}^{1)}$	13 FIT	
$\lambda_{du}^{1)}$	113 FIT	100 FIT
PFDAvg for $T_1 = 1$ year	4.96×10^{-4}	4.37×10^{-4}
MTBF	153 years	
Diagnostic test interval ²⁾	≤60 s	
Fault reaction time ³⁾	≤3 s	
System reaction time ⁴⁾	1 s (covered > free)	0.5 s (free > covered)
PTC test sequence A ⁵⁾	92 %	
PTC test sequence B ⁶⁾	34 %	38 %
PTC test sequence C ⁷⁾	-	92 %

- 1) This value takes into account failure types relevant to the function of the electronic components according to Siemens SN29500.
- 2) During this time, all diagnostic functions are executed at least once.
- 3) Time between error detection and error response.
- 4) Step response time as per DIN EN 61298-2.
- 5) Proof test coverage when the level is approached, or when the sensor is removed and the tines are immersed in a medium of similar density and viscosity.
- 6) Proof test coverage when simulation is performed on the Nivotester or electronic insert FEL58 by activating the test button.
- 7) Proof test coverage when checking the switch point under reference operating conditions.

Version III: Liquiphant M/S; 3-channel Nivotester FTL325N, CH2 and CH3 in series

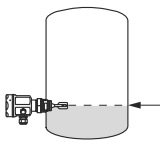
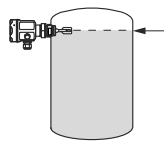
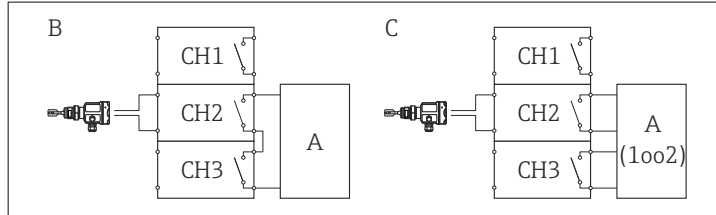
Characteristics as per IEC 61508	Value	
Safety function	MIN	MAX
Example		
Wiring scheme	 <p> A Other safety equipment e.g. actuator/safety-related PLC B Possibility 1 C Possibility 2; 1oo2 assessment </p>	
SIL	2	
HFT	0	
Device type	B	
Mode of operation	Low demand mode	
SFF	91 %	93 %
MTTR	8 h	
$\lambda_{sd}^{1)}$	72 FIT	84 FIT
$\lambda_{su}^{1)}$	809 FIT	812 FIT
$\lambda_{dd}^{1)}$	13 FIT	
$\lambda_{du}^{1)}$	84 FIT	70 FIT
PFDA _{avg} for T ₁ = 1 year	3.67 x 10 ⁻⁴	3.08 x 10 ⁻⁴
MTBF	117 years	
Diagnostic test interval ²⁾	≤60 s	
Fault reaction time ³⁾	≤3 s	
System reaction time ⁴⁾	1 s (covered > free)	0.5 s (free > covered)
PTC test sequence A ⁵⁾	96 %	
PTC test sequence B ⁶⁾	51 %	56 %
PTC test sequence C ⁷⁾	-	96 %

- 1) This value takes into account failure types relevant to the function of the electronic components according to Siemens SN29500.
- 2) During this time, all diagnostic functions are executed at least once.
- 3) Time between error detection and error response.
- 4) Step response time as per DIN EN 61298-2.
- 5) Proof test coverage when the level is approached, or when the sensor is removed and the tines are immersed in a medium of similar density and viscosity.
- 6) Proof test coverage when simulation is performed on the Nivotester or electronic insert FEL58 by activating the test button.
- 7) Proof test coverage when checking the switch point under reference operating conditions.

Version IV: 2 Liquiphant M/S; 3-channel Nivotester FTL325N

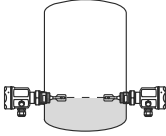
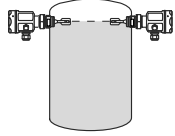
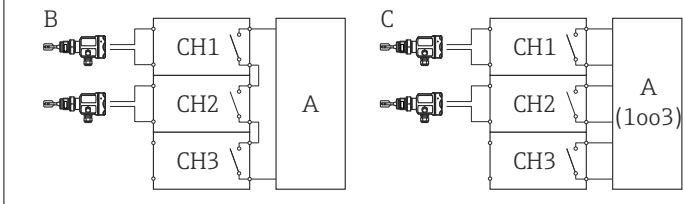
Characteristics as per IEC 61508	Value	
Safety function	MIN	MAX
Example		
Wiring scheme	 <p>A Other safety equipment e.g. actuator/safety-related PLC B Possibility 1 C Possibility 2; 1oo3 assessment</p>	
SIL	2	
HFT	1	
Device type	B	
Mode of operation	Low demand mode	
SFF	99 %	
MTTR	8 h	
$\lambda_{sd}^{1)}$	163 FIT	187 FIT
λ_{su}	1252 FIT	1231 FIT
λ_{dd}	1 FIT	
λ_{du}	17 FIT	15 FIT
PFDAvg for $T_1 = 1$ year	7.27×10^{-5}	6.68×10^{-5}
MTBF	80 years	
Diagnostic test interval ²⁾	≤60 s	
Fault reaction time ³⁾	≤3 s	
System reaction time ⁴⁾	1 s (covered > free)	0.5 s (free > covered)
PTC test sequence A ⁵⁾	92 %	
PTC test sequence B ⁶⁾	34 %	38 %
PTC test sequence C ⁷⁾	-	92 %

- 1) This value takes into account failure types relevant to the function of the electronic components according to Siemens SN29500.
- 2) During this time, all diagnostic functions are executed at least once.
- 3) Time between error detection and error response.
- 4) Step response time as per DIN EN 61298-2.
- 5) Proof test coverage when the level is approached, or when the sensor is removed and the tines are immersed in a medium of similar density and viscosity.
- 6) Proof test coverage when simulation is performed on the Nivotester or electronic insert FEL58 by activating the test button.
- 7) Proof test coverage when checking the switch point under reference operating conditions.



The failure rates are based on an analysis in accordance with DIN EN 61508-6: 2011-02, Table D.4, "Using the β -factor to calculate the probability of failure in an E/E/PE safety-related system due to common cause failures". The calculation gives a β -factor of 10 %. This factor is based on the failure rates indicated above. If additional measures are implemented during installation to prevent common cause errors as defined in Table D.1, the β -factor can possibly be reduced to 5 %. Possible measures are:

- Sensors installed in a physically separate location
- Cable routed separately between the Liquiphant and Nivotester
- Separate protection from environmental influences: impact, sunshine, EMC protection and/or overvoltage
- Use of different sensor materials, and combination of high-temperature and normal version

Version V: 3 Liquiphant M/S; 3-channel Nivotester FTL325N; 2oo3 architecture

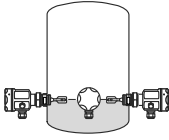
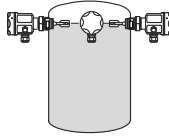
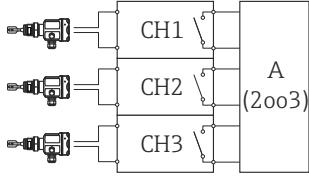
Characteristics as per IEC 61508	Value	
Safety function	MIN	MAX
Example		
Wiring scheme	 <p><i>A Other safety equipment e.g. actuator/safety-related PLC; 2oo3 assessment</i></p>	
SIL	2	
HFT	1	
Device type	B	
Mode of operation	Low demand mode	
SFF	99 %	
MTTR	8 h	
$\lambda_{sd}^{1)}$	242 FIT	277 FIT
λ_{su}	1448 FIT	1416 FIT
λ_{dd}	1 FIT	
λ_{du}	19 FIT	17 FIT
PFDAvg for $T_1 = 1$ year	8.13×10^{-5}	7.55×10^{-5}
MTBF	67 years	
Diagnostic test interval ²⁾	≤60 s	
Fault reaction time ³⁾	≤3 s	
System reaction time ⁴⁾	1 s (covered > free)	0.5 s (free > covered)
PTC test sequence A ⁵⁾	92 %	
PTC test sequence B ⁶⁾	34 %	38 %
PTC test sequence C ⁷⁾	-	92 %

- 1) This value takes into account failure types relevant to the function of the electronic components according to Siemens SN29500.
- 2) During this time, all diagnostic functions are executed at least once.
- 3) Time between error detection and error response.
- 4) Step response time as per DIN EN 61298-2.
- 5) Proof test coverage when the level is approached, or when the sensor is removed and the tines are immersed in a medium of similar density and viscosity.
- 6) Proof test coverage when simulation is performed on the Nivotester or electronic insert FEL58 by activating the test button.
- 7) Proof test coverage when checking the switch point under reference operating conditions.



The failure rates are based on an analysis in accordance with DIN EN 61508-6: 2011-02, Table D.4, "Using the β -factor to calculate the probability of failure in an E/E/PE safety-related system due to common cause failures". The calculation gives a β -factor of 10 %. This factor is based on the failure rates indicated above. If additional measures are implemented during installation to prevent common cause errors as defined in Table D.1, the β -factor can possibly be reduced to 5 %. Possible measures are:

- Sensors installed in a physically separate location
- Cable routed separately between the Liquiphant and Nivotester
- Separate protection from environmental influences: impact, sunshine, EMC protection and/or overvoltage
- Use of different sensor materials, and combination of high-temperature and normal version

Version VI: Liquiphant M/S; 3-channel Nivotester FTL325N

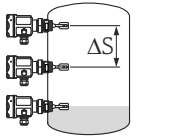
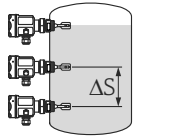
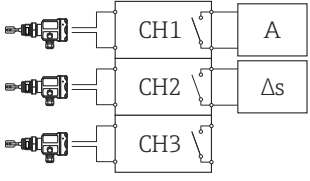
Characteristics as per IEC 61508	Value	
Safety function	MIN	MAX
Example		
Wiring scheme	 <p><i>A Other safety equipment e.g. actuator/safety-related PLC Δs level control (not SIL)</i></p>	
SIL	2	
HFT	0	
Device type	B	
Mode of operation	Low demand mode	
SFF	85 %	87 %
MTTR	8 h	
$\lambda_{sd}^{1)}$	66 FIT	78 FIT
λ_{su}	554 FIT	
λ_{dd}	13 FIT	
λ_{du}	113 FIT	100 FIT
PFDAvg for T ₁ = 1 year	4.96 x 10 ⁻⁴	4.37 x 10 ⁻⁴
MTBF	153 years	
Diagnostic test interval ²⁾	≤60 s	
Fault reaction time ³⁾	≤3 s	
System reaction time ⁴⁾	1 s (covered > free)	0.5 s (free > covered)
PTC test sequence A ⁵⁾	92 %	
PTC test sequence B ⁶⁾	34 %	38 %
PTC test sequence C ⁷⁾	-	92 %

- 1) This value takes into account failure types relevant to the function of the electronic components according to Siemens SN29500.
- 2) During this time, all diagnostic functions are executed at least once.
- 3) Time between error detection and error response.
- 4) Step response time as per DIN EN 61298-2.
- 5) Proof test coverage when the level is approached, or when the sensor is removed and the tines are immersed in a medium of similar density and viscosity.
- 6) Proof test coverage when simulation is performed on the Nivotester or electronic insert FEL58 by activating the test button.
- 7) Proof test coverage when checking the switch point under reference operating conditions.

Useful lifetime of electrical components

The established failure rates of electrical components apply within the useful lifetime as per IEC 61508-2:2010 section 7.4.9.5 note 3.

According to DIN EN 61508-2:2011 section 7.4.9.5 national footnote N3, appropriate measures taken by the manufacturer and operator can extend the useful lifetime.

Certificate

Certificate			
			
Nr./No.: 968/FSP 1148.00/15			
Prüfgegenstand Product tested	Füllstandswächter Level monitor	Zertifikats- inhaber Certificate holder	Endress + Hauser GmbH + Co. KG Hauptstraße 1 79689 Maulburg Germany
Typbezeichnung Type designation	Liquiphant M/S with FEL56/58/57 + Nivotester FTL 325 N or FTL 325 P, Soliphant M with FEM57 + Nivotester FTL 325 P Possible device combinations see backside of this certificate.		
Prüfgrundlagen Codes and standards	IEC 61508 Parts 1-7:2010		
Bestimmungsgemäße Verwendung Intended application	Die Geräte erfüllen die Anforderungen der Prüfgrundlagen (Hardware Sicherheitsintegrität SIL 2 nach IEC 61508 und systematische Eignung SIL 3 nach IEC 61508) und können in Anwendungen bis SIL 2 (HFT=0) bzw. SIL 3 (HFT=1) nach IEC 61508 für die Sicherheitsfunktionen MIN oder MAX Füllstandsüberwachung eingesetzt werden. The devices comply with the requirements of the relevant standards (Hardware safety integrity SIL 2 acc. to IEC 61508 and systematic capability SIL 3 acc. to IEC 61508) and can be used in applications up to SIL 2 (HFT=0) resp. SIL 3 (HFT=1) acc. to IEC 61508 for the safety functions MIN or MAX level monitoring.		
Besondere Bedingungen Specific requirements	Die Hinweise in der zugehörigen Betriebsanleitung und dem Sicherheitshandbuch sind zu beachten. The instructions of the associated Operating Manual and Safety Manual shall be considered.		
Gültig bis / Valid until 2020-10-05			
Der Ausstellung dieses Zertifikates liegt eine Prüfung zugrunde, deren Ergebnisse im Bericht Nr. 968/FSP 1148.00/15 vom 05.10.2015 dokumentiert sind. Dieses Zertifikat ist nur gültig für Erzeugnisse, die mit dem Prüfgegenstand übereinstimmen. Es wird ungültig bei jeglicher Änderung der Prüfgrundlagen für den angegebenen Verwendungszweck. The issue of this certificate is based upon an examination, whose results are documented in Report No. 968/FSP 1148.00/15 dated 2015-10-05. This certificate is valid only for products which are identical with the product tested. It becomes invalid at any change of the codes and standards forming the basis of testing for the intended application.			
TÜV Rheinland Industrie Service GmbH Bereich Automation Funktionale Sicherheit Am Grauen Stein, 51105 Köln Certification Body for FS-Products		 Dipl.-Ing. Stephan Häb	
Köln, 2015-10-05			
www.fs-products.com www.tuv.com		 TÜVRheinland® Precisely Right.	

10222 12, 12, E M 4 © TÜV, TÜEV and TÜV are registered trademarks. Utilisation and application requires prior approval.

TÜV Rheinland Industrie Service GmbH, Am Grauen Stein, 51105 Köln / Germany
Tel.: +49 221 806-1700, Fax: +49 221 806-1530, E-Mail: industrie-service@tuv.com

A0028061

Document information

Document function

The document is part of the Operating Instructions and serves as a reference for application-specific parameters and notes.



- General information about functional safety: SIL
- General information about SIL is available:
In the Download Area of the Endress+Hauser Internet site: www.de.endress.com/SIL

Symbols used

Safety symbols

Symbol	Meaning
	DANGER! This symbol alerts you to a dangerous situation. Failure to avoid this situation will result in serious or fatal injury.
	WARNING! This symbol alerts you to a dangerous situation. Failure to avoid this situation can result in serious or fatal injury.
	CAUTION! This symbol alerts you to a dangerous situation. Failure to avoid this situation can result in minor or medium injury.
	NOTE! This symbol contains information on procedures and other facts which do not result in personal injury.

Symbols for certain types of information

Symbol	Meaning
 <small>A0011193</small>	Tip Indicates additional information.
	Reference to documentation
	Reference to page
	Reference to graphic
	Series of steps

Symbols in graphics

Symbol	Meaning
1, 2, 3,...	Item numbers
	Series of steps
A, B, C, ...	Views

Supplementary device documentation

Liquiphant M FTL50, FTL50H, FTL51, FTL51H, FTL51C

Documentation	Comment
Technical Information: <ul style="list-style-type: none"> ■ TI00328F/00 (FTL50, FTL50H, FTL51, FTL51H) ■ TI00347F/00 (FTL51C) 	The documentation is available on the Internet: → www.endress.com
Operating Instructions: <ul style="list-style-type: none"> ■ KA00143F/00 (FTL50, FTL51) ■ KA00163F/00 (FTL50, FTL51¹⁾) ■ KA00144F/00 (FTL50H, FTL51H) ■ KA00164F/00 (FTL50H, FTL51H¹⁾) ■ KA00162F/00 (FTL51C) ■ KA00165F/00 (FTL51C¹⁾) 	<ul style="list-style-type: none"> ■ The document is provided with the device. ■ The documentation is available on the Internet: → www.endress.com
Safety instructions depending on the selected option "Approval".	Additional safety instructions (XA, ZE) are supplied with certified device version. Please refer to the nameplate for the relevant safety instructions.

1) with T13 aluminum housing/separate connection compartment

Liquiphant S FTL70, FTL71

Documentation	Comment
Technical Information: TI00354F/00	The documentation is available on the Internet: → www.endress.com
Operating Instructions: <ul style="list-style-type: none"> ■ KA00172F/00 ■ KA00173F/00¹⁾ 	<ul style="list-style-type: none"> ■ The document is provided with the device. ■ The documentation is available on the Internet: → www.endress.com
Safety instructions depending on the selected option "Approval".	Additional safety instructions (XA, ZE) are supplied with certified device version. Please refer to the nameplate for the relevant safety instructions.

1) with T13 aluminum housing/separate connection compartment

Nivotester FTL325N

Documentation	Comment
Technical Information: TI00353F/00	The documentation is available on the Internet: → www.endress.com
Operating Instructions: <ul style="list-style-type: none"> ■ KA00170F/00 (1-channel) ■ KA00171F/00 (3-channel) 	<ul style="list-style-type: none"> ■ The document is provided with the device. ■ The documentation is available on the Internet: → www.endress.com
Safety instructions depending on the selected option "Approval".	Additional safety instructions (XA, ZE) are supplied with certified device version. Please refer to the nameplate for the relevant safety instructions.

 This supplementary Safety Manual applies in addition to the Operating Instructions, Technical Information and ATEX Safety Instructions. The supplementary device documentation must be observed during installation, commissioning and operation. The requirements specific for the protection function are described in this Safety Manual.

Permitted devices types

The details pertaining to functional safety in this manual relate to the device versions listed below and are valid as of the specified firmware and hardware versions. Unless otherwise specified, all the following versions can also be used for protective systems. A modification process according to IEC 61508 is applied for device changes.

Valid device versions for safety-related use: Liquiphant M FTL50, FTL50H, FTL51, FTL51H, FTL51C

Ordering feature	Designation	Option
010	Approval	All
020	Process connection	All
030	Probe length; type	All
040	Electronics; output	8 FEL58; SIL NAMUR+test button (L-H signal)
050	Housing; cable entry	All
060	Additional options	All
570	Service	All
580	Test, certificate	All
600	Sensor design	All
895	Marking	All

- Valid firmware version: 01.00.01 and higher
- Valid hardware version: 01.01 and higher

Valid device versions for safety-related use: Liquiphant S FTL70, FTL71

Ordering feature	Designation	Option
010	Approval	All
020	Process connection	All
030	Probe length	All
040	Electronics; output	8 FEL58; SIL NAMUR+test button (L-H signal)
050	Housing; cable entry	All
060	Additional options	All
070	Application	All
570	Service	All
580	Test, certificate	All
600	Sensor design	All
895	Marking	All

- Valid firmware version: 01.00.01 and higher
- Valid hardware version: 01.01 and higher

Valid device versions for safety-related use: Nivotester FTL325N

Ordering feature	Designation	Option
010	Approval	<ul style="list-style-type: none"> ▪ G ATEX II 3(1)G Ex nC/A [ia] IIC T4, SIL, IECEx Zone 2 ▪ H ATEX II (1)GD [EEx ia] IIC, WHG, SIL, IECEx [Ex ia] IIC ▪ N NEPSI (Ex ia) IIC, SIL ▪ P FM IS Cl. I, II, III Div. 1 Gr. A-G, SIL ▪ T CSA IS Cl. I, II, III Div. 1 Gr. A-G, SIL ▪ W TIIS Ex ia IIC, SIL, labeling in Japan ▪ 2 INMETRO [Ex ia Ga] IIC, SIL ▪ 8 EAC [Ex ia Ga] IIC SIL; EAC [Ex ia Da] IIC, SIL
020	Housing	<ul style="list-style-type: none"> ▪ 1 Rail mounting, 22.5 mm, 1-channel ▪ 3 Rail mounting, 45mm, 3-channel
030	Power connection	All
040	Switch output	<ul style="list-style-type: none"> ▪ 1 1x SPDT level + 1x SPST alarm ▪ 3 3x SPDT level + 1x SPST alarm
995	Marking	All

Valid hardware version: 02.00 and higher

SIL label on the nameplate



SIL certified devices are marked with the following symbol on the nameplate:

Safety function

Definition of the safety function

The measuring system's safety functions are:

- Maximum point level monitoring (overflow protection)
- Minimum point level monitoring (dry run protection)



For information on the choice of operating mode (MIN or MAX detection), see → 22.

Restrictions for use in safety-related applications

- The measuring system must be used correctly for the specific application, taken into account the medium properties and ambient conditions. Carefully follow instructions pertaining to critical process situations and installation conditions from the Operating Instructions. The application-specific limits must be observed.
- The specifications from the Operating Instructions must not be exceeded, (→ 16).

Density of the medium

Operation is only permitted with liquids:

- Depending on the configured density setting, the density of the liquid must be as follows:
 - if the switch position is > 0.7 the density must be over 0.7 g/cm³ (common water- and oil-based liquids).
 - if the switch position is > 0.5 the density must be over 0.5 g/cm³ (e.g. liquefied gas, isopentane, petroleum ether).
- The gas phase above the liquid may not exceed a maximum permitted density value. The maximum possible gas density depends on the temperature and the device.

CAUTION

Gas density is exceeded!

"Free" state is not detected and "Covered" is always signaled.

- ▶ The gas density may not be exceeded.

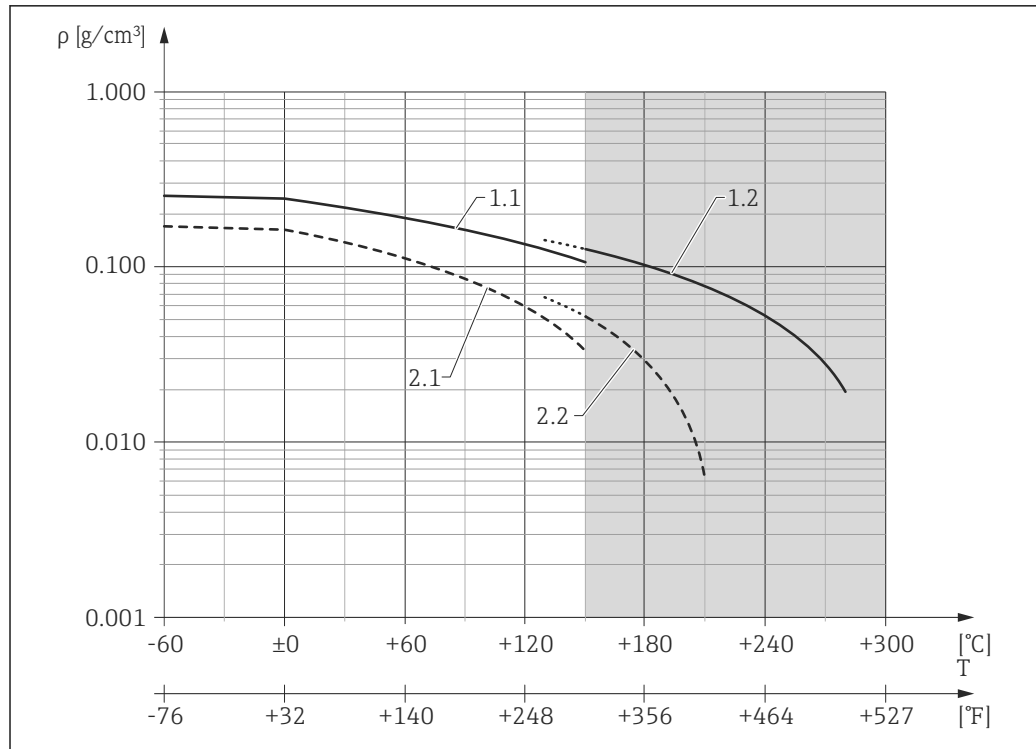

- 1.1 Liquiphant M; density switch position 0.7 g/cm³
 1.2 Liquiphant S; density switch position 0.7 g/cm³
 2.1 Liquiphant M; density switch position 0.5 g/cm³
 2.2 Liquiphant S; density switch position 0.5 g/cm³

- i** There is no minimum density for the gas phase. Operation in a vacuum is permitted!
- There is no maximum density for the liquid.
- For more information on the levels of diagnostic coverage, refer to IEC 61508-2:2010 Appendix A.2, Comment 2 and Table A.1.

Buildup (only for minimum detection)

The device may only be used in media that do not tend to cause buildup. Buildup is considered to be any deposits with a thickness of over 0.5 mm (0.02 in). Buildup can have the effect that the demand mode of the safety function is not detected and the device will not switch as intended.

- i** Buildup from 0.5 mm (0.02 in) is detected with low diagnostic coverage.

Solid particles - heterogeneous mixtures (only for minimum detection)

The medium may not contain solid particles with a diameter greater than 5 mm (0.2 in). Solid particles lodged between the tines of the tuning fork can have the effect that the demand mode of the safety function is not detected and the device will not switch as intended.

- i** Lodged solid particles are detected with low diagnostic coverage.

Hydrogen diffusion (only Liquiphant S - high temperature)

If there is a danger of hydrogen diffusion, the device may not be used if the following conditions apply simultaneously. Hydrogen entering the device damages the sensor to the extent that the demand mode of the safety function is not detected and the device does not switch as intended.

- Not over +180 °C (+356 °F) and simultaneously
- Not over 64 bar (928 psi)

- i** The error is not detected by the diagnostics system.

Wall distance

The distance between the tuning fork of the device and the wall of the vessel containing medium (e.g. tank, pipe) must be at least 10 mm (0.39 in).

Corrosion

The device may only be used in media to which the wetted parts used are resistant. Corrosion can have the effect that the demand mode of the safety function is not detected and the device will not switch as intended.



Corrosion is detected with low diagnostic coverage.

If coated sensors are used, measures must be taken to ensure there is no damage during installation and operation.

Abrasion

The device may not be used or cleaned in abrasive media. Material removal can have the effect that the demand mode is not detected.



Abrasion is detected with low diagnostic coverage.

Flow velocity

In the case of flowing media, the flow velocity in the area around the tuning fork may not exceed 5 m/s. Higher flow velocities can have the effect that the demand mode is not detected and the sensor signals that it is free (uncovered).

External vibration

In systems exposed to strong external vibrations, e.g. in the 400 to 1200 Hz range (acceleration spectral density $>1 \text{ (m/s}^2\text{)}^2\text{/Hz}$) or ultrasound with cavitation, the safety function must be verified by simulating a demand mode prior to operation. Accidental switchings may sporadically occur if a strong frequency from an external source is superimposed on the frequency of the tuning fork.

EMC compatibility

The device is certified in accordance with IEC 61326-3-2 and is therefore suitable for safety-related, industrial applications in a specified electromagnetic environment. If the specified electromagnetic ambient conditions are exceeded, the switch status might not be reliably detected. An unshielded cable up to 1000 m (3281 ft) long can be used between the devices in these environmental conditions. Electromagnetic interference immunity can be further improved by using shielded cables.

Mounting the Liquiphant M FTL51 with sliding sleeve

Particular care is required when mounting the device with a pipe extension in conjunction with a sliding sleeve. The operator must implement appropriate measures to ensure that the switch point is not tampered with or that any tampering is reliably detected.

Use in safety instrumented systems

Device behavior during operation

Behavior of device during power-up

The behavior of the device during power-up is described in the relevant Operating Instructions (→  16).

Device behavior in safety function demand mode

Version I

The safety-related output signal consists of a current signal according to the NAMUR interface as per EN 50227 (DIN 19234; NAMUR) or IEC 60947-5-6.

- In the GOOD state, the current at terminal 2 is between 2.2 to 3.5 mA
- In demand mode, or if a fault is detected in the device, this current decreases to 0.6 to 1.0 mA
- In the event of a cable open circuit or similar faults, the current is <0.6 mA
- In the event of a short-circuit or similar faults, the current is >3.5 mA

IEC 60947-5-6 defines ranges in which the switch points may be, see "Figure 3 - Control input of the switching amplifier" in the standard. Accordingly, the calculation of the safety-related characteristic values is based on the requirement that the downstream evaluation detects the following currents (Nivotester FTL325N meets this requirement):

- < 0.05 mA reliably detected as a cable open circuit
- > 6.6 mA reliably detected as a short-circuit

Version II to VI

The safety-related output signal consists of one switching contact per channel:
Channel 1: terminal 4 and 5

With the 3-channel Nivotester, also:

- Channel 2: terminal 22 and 23
- Channel 3: terminal 26 and 27

 The switching contacts work with quiescent current safety; they are closed in the GOOD state.

The switching contacts are de-energized in the following situations:

- In demand mode
- If a fault is detected
- If the supply voltage fails

Behavior of device in event of alarms and warnings

The behavior of the device if alarms or warnings occur is described in the relevant Operating Instructions (→  16).

Device configuration for safety-related applications

The device configuration may not be changed if SIL operation is in progress.

Recommendation: perform a proof test after configuring to ensure that the safety function is working correctly.

Configuring the Liquiphant

CAUTION

The permitted contact values of the relays may not be exceeded

- ▶ The operator must take suitable measures to ensure that the permitted contact values of the relays ($U \leq 253 V_{AC}$ 50/60 Hz, $I \leq 2 A$, $P \leq 500 VA$ at $\cos \varphi \geq 0.7$ or $U \leq 40 V_{DC}$, $I \leq 2 A$, $P \leq 80 W$) are not exceeded (e.g. current limiter, fuse).

CAUTION

The protective function can be impaired

- ▶ After commissioning the measuring system, changes to the settings can impact the protective function.

Mode of operation

Switch on the operating mode at the left switch:

Mode of operation	Function	Switch position
MAX safety	MAX	Top
MIN safety	MIN	Bottom

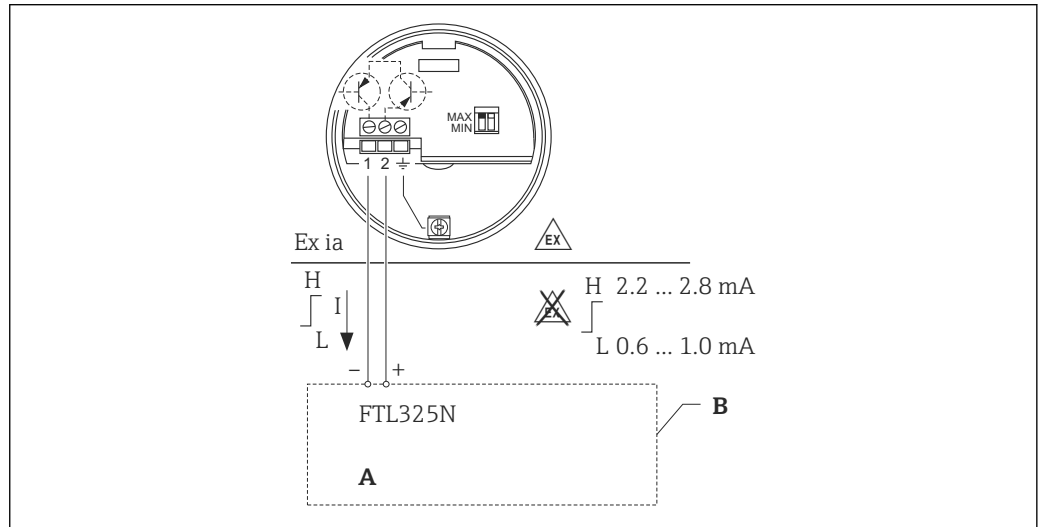

A0027861

- A Multiplexer: cycle time >2 s
- B Isolating amplifier as per NAMUR (IEC 60947-5-6)

Density

Set the density at the right switch:

Liquid density	Function	Switch position	Comment
$>0.7 \text{ kg/dm}^3$	>0.7	Top (See A in the graphic below)	Standard setting; Always use if possible
$>0.5 \text{ kg/dm}^3$	>0.5	Bottom (See B in the graphic below)	Special settings; Extremely light liquids (e.g.: liquefied natural gas)

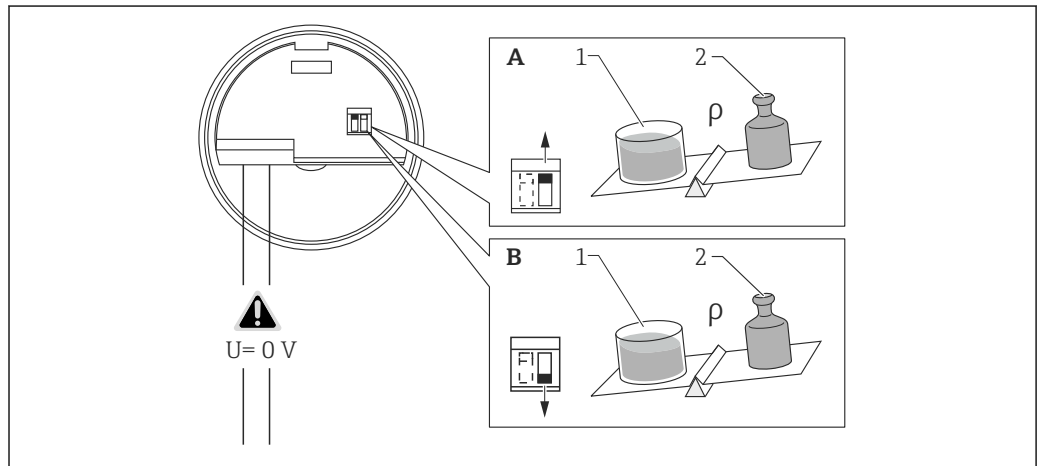

A0026156

- A Standard setting (density $>0.7 \text{ kg/dm}^3$)
- A1 1 l (0.264 gal) or 1 dm^3 (61.02 in³)
- A2 $>0.7 \text{ kg}$ (1.54 lbs)
- B Special setting (density $>0.5 \text{ kg/dm}^3$)
- B1 1 l (0.264 gal) or 1 dm^3 (61.02 in³)
- B2 >0.5 to 0.7 kg (1.10 to 1.54 lbs)

Configuring the Nivotester

Version	Switch		Channel 2 ¹⁾	Fault message	Channel 3 ¹⁾	Fault message	MODE ¹⁾
	Channel 1	Fault message					
	1	2	4	3	2	1	
II	L = Low 0.4 to 1.2 mA	With	Not applicable				
III		None	L = Low 0.4 to 1.2 mA	With	L = Low 0.4 to 1.2 mA	With	2
IV		With					2
V							3
VI							1

1) Only for 3-channel Nivotester FTL325N

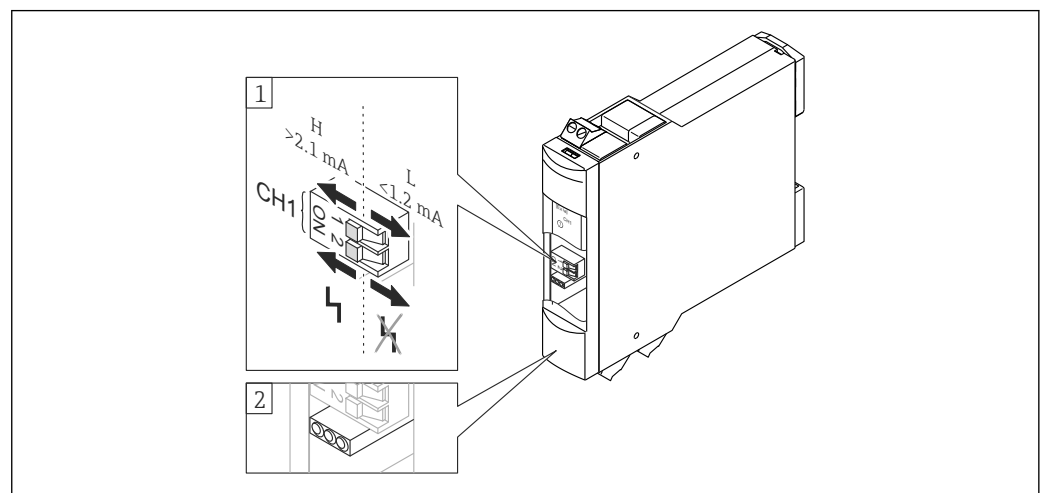

1 Operating and display element, 1-channel Nivotester FTL325N

1 DIL switch: error current signal 2.1 mA / 1.2 mA (1), fault on/off position (2)

2 Light emitting diodes (LEDs)

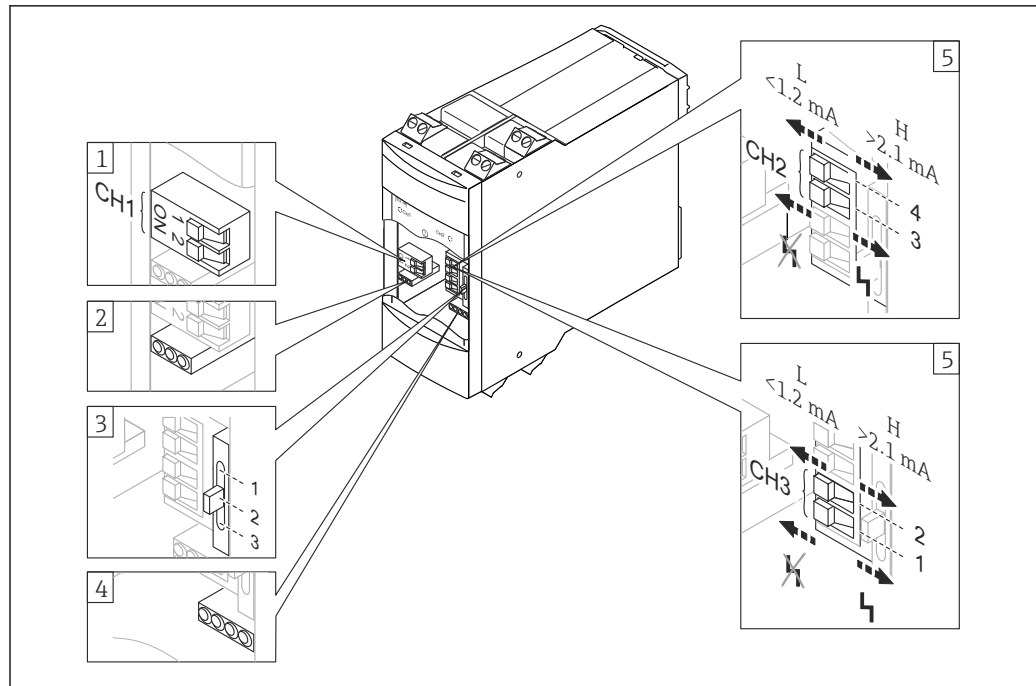

2 Operating and display element, 3-channel Nivotester FTL325N

- 1 DIL switch for channel 1: error current signal 2.1 mA / 1.2 mA (1), fault on/off position (2)
- 2 Light emitting diodes (LEDs)
- 3 Switch for functions: Δs , e.g. pump control (1), two level relays (2), individual channels (3)
- 4 Light emitting diodes (LEDs)
- 5 DIL switch for channel 2 and 3: fault on/off position (1/3), error current signal 2.1 mA / 1.2 mA (2/4)

Proof-testing

Check the operativeness and safety of safety functions at appropriate intervals! The operator must determine the time intervals.

The values and figures in the "Additional safety-related characteristic values" section can be used to this end, → 5. The check must be carried out in such a way that it is proven that the protective system functions perfectly in interaction with all components.

Proof-testing can be performed as follows:

- Test sequence A:
Approach the level or remove and immerse in a medium of similar density and viscosity.
- Test sequence B:
Activate simulation by pressing the test button on the Liquiphant or Nivotester.
- Test sequence C
Check the switch point under reference operating conditions

NOTICE

Ensuring correct device sealing!

- ▶ You must also check and ensure that all cover seals and cable entries are sealing correctly.

Procedure of the proof-test

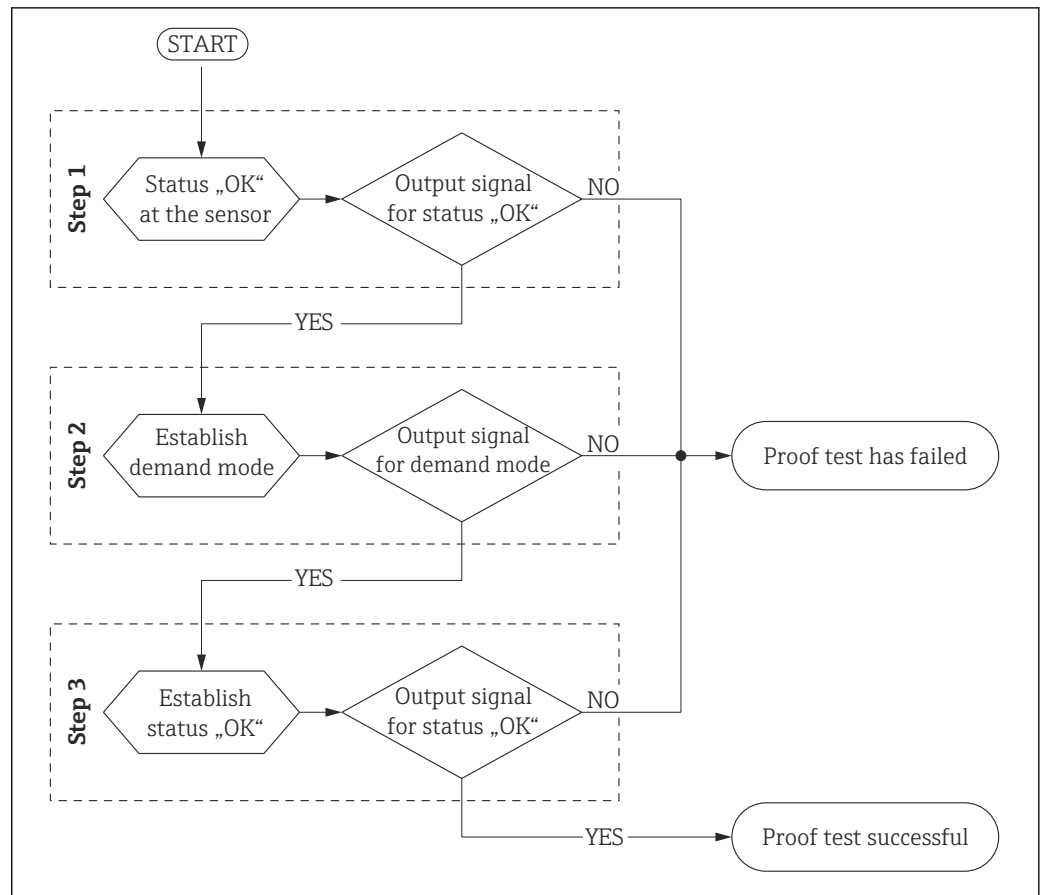

A0026161-EN

A demand mode or a fault takes absolute precedence over the proof test and in the measuring system safety path. For this reason, the demand mode must first be ended or the fault rectified before the proof test can commence. It is advisable to also check that the alarm relay (terminal 15 and 16) has not de-energized (no fault is present) at the start of the proof test (step 1).

i The proof test can and may only be performed if the device state is GOOD.

The status of the individual output signal is indicated by a measuring device or a downstream component of the safety path (e.g. safety-related PLC, actuator). For more information, → 40.

i It is advisable to document the steps of the proof test (→ 42).

Version I	Mode of operation	
	MIN	MAX
Approach the level	Version I, test sequence A, MIN detection (→ 29)	Version I, test sequence A, MAX detection (→ 30)
Remove and immerse in a medium of similar density and viscosity		
Activate simulation by pressing the test button on the Liquiphant or Nivotester.	Version I, test sequence B (→ 33)	
Check the switch point under reference operating conditions	-	Version I, test sequence C, MAX detection (→ 35)

Version II to VI	Mode of operation	
	MIN	MAX
Approach the level	Version II to VI, test sequence A, MIN detection (→ 31)	Version II to VI, test sequence A, MAX detection (→ 32)
Remove and immerse in a medium of similar density and viscosity		
Activate simulation by pressing the test button on the Liquiphant or Nivotester.	Version II to VI, test sequence B (→ 34)	
Activate simulation by pressing the test button on the Nivotester.		
Check the switch point under reference operating conditions	-	Version II to VI, test sequence C, MAX detection (→ 36)

Version I, test sequence A, MIN detection

- Approach the level or
- Remove and immerse in a medium of similar density and viscosity

Step 1

1. Raise the level or immerse the tuning fork of the sensor that has been removed into the medium until the tuning fork is fully covered.
 - ↳ If it is not possible to do this with the original medium, a medium of a similar density and viscosity must be used.
2. Check the current at terminal 2.
 - ↳ After immersing the fork (plus a response time of approx. 1 s), the current must be between 2.2 to 3.5 mA.



If the current is outside the specified tolerance, a fault has occurred in the safety path. The proof test has not been passed and must be aborted.

Step 2

1. Lower the level or remove the tuning fork of the sensor that has been removed out of the medium until the tuning fork is completely free.
2. Check the current at terminal 2.
 - ↳ After retracting the fork (plus a response time of approx. 1 s), the current must be between 0.6 to 1.0 mA.



If the current is outside the specified tolerance, a fault has occurred in the safety path. The proof test has not been passed and must be aborted.

Step 3

1. Re-install the sensor that was removed.
2. Restore the GOOD state by fully covering the tuning fork.
3. Check the current at terminal 2.
 - ↳ After immersing the fork (plus a response time of approx. 2 s) or after the voltage is restored (plus a response time of approx. 3 s), the current must be between 2.2 to 3.5 mA.



If the current is outside the specified tolerance, a fault has occurred in the safety path. The proof test has not been passed and must be aborted.

Version I, test sequence A, MAX detection

- Approach the level or
- Remove and immerse in a medium of similar density and viscosity

Step 1

1. Lower the level or remove the tuning fork of the sensor that has been removed out of the medium until the tuning fork is completely free.
 - ↳ If it is not possible to do this with the original medium, a medium of a similar density and viscosity must be used.
2. Check the current at terminal 2.
 - ↳ The current must be between 2.2 to 3.5 mA.

 If the current is outside the specified tolerance, a fault has occurred in the safety path. The proof test has not been passed and must be aborted.

Step 2

1. Raise the level or immerse the tuning fork of the sensor that has been removed into the medium until the tuning fork is fully covered.
2. Check the current at terminal 2.
 - ↳ After immersing the fork (plus a response time of approx. 1 s), the current must be between 0.6 to 1.0 mA.

 If the current is outside the specified tolerance, a fault has occurred in the safety path. The proof test has not been passed and must be aborted.

Step 3

1. Re-install the sensor that was removed.
2. Restore the GOOD state by fully exposing the tuning fork.
3. Check the current at terminal 2.
 - ↳ After retracting the fork (plus a response time of approx. 2 s) or after the voltage is restored (plus a response time of approx. 3 s), the current must be between 2.2 to 3.5 mA.

 If the current is outside the specified tolerance, a fault has occurred in the safety path. The proof test has not been passed and must be aborted.

Version II to VI, test sequence A, MIN detection

- Approach the level or
- Remove and immerse in a medium of similar density and viscosity

Step 1

1. Raise the level or immerse the tuning fork of the sensor that has been removed into the medium until the tuning fork is fully covered.
 - ↳ If it is not possible to do this with the original medium, a medium of a similar density and viscosity must be used.
2. Check the status of the safety contacts.

Terminal	Version				
	II	III	IV	V	VI
4+5	Closed	Not applicable	Closed	Closed	Closed
22+23	Not applicable	Closed	Closed	Closed	Not applicable
26+27	Not applicable	Closed	Closed	Closed	Not applicable

 If one or more safety contacts are open, a fault has occurred in the safety path. The proof test has not been passed and must be aborted.

Step 2

1. Lower the level or remove the tuning fork of the sensor that has been removed out of the medium until the tuning fork is completely free.
2. After immersing the fork (plus a response time of approx. 1 s), check the status of the safety contacts.

Terminal	Version				
	II	III	IV	V	VI
4+5	Open	Not applicable	Open	Open	Open
22+23	Not applicable	Open	Open	Open	Not applicable
26+27	Not applicable	Open	Open	Open	Not applicable

 If one or more safety contacts are closed, a fault has occurred in the safety path. The proof test has not been passed and must be aborted.

Step 3

1. Re-install the sensor that was removed.
2. Restore the GOOD state by fully covering the tuning fork.
3. After immersing the fork (plus a response time of approx. 2 s) or after the voltage is restored (plus a response time of approx. 3 s), check the status of the safety contacts.

Terminal	Version				
	II	III	IV	V	VI
4+5	Closed	Not applicable	Closed	Closed	Closed
22+23	Not applicable	Closed	Closed	Closed	Not applicable
26+27	Not applicable	Closed	Closed	Closed	Not applicable

 If one or more safety contacts are open, a fault has occurred in the safety path. The proof test has not been passed and must be aborted.

Version II to VI, test sequence A, MAX detection

- Approach the level or
- Remove and immerse in a medium of similar density and viscosity

Step 1

1. Lower the level or remove the tuning fork of the sensor that has been removed out of the medium until the tuning fork is completely free.
 - ↳ If it is not possible to do this with the original medium, a medium of a similar density and viscosity must be used.
2. Check the status of the safety contacts.

Terminal	Version				
	II	III	IV	V	VI
4+5	Closed	Not applicable	Closed	Closed	Closed
22+23	Not applicable	Closed	Closed	Closed	Not applicable
26+27	Not applicable	Closed	Closed	Closed	Not applicable

i If one or more safety contacts are open, a fault has occurred in the safety path. The proof test has not been passed and must be aborted.

Step 2

1. Raise the level or immerse the tuning fork of the sensor that has been removed into the medium until the tuning fork is fully covered.
2. After immersing the fork (plus a response time of approx. 1), check the status of the safety contacts.

Terminal	Version				
	II	III	IV	V	VI
4+5	Open	Not applicable	Open	Open	Open
22+23	Not applicable	Open	Open	Open	Not applicable
26+27	Not applicable	Open	Open	Open	Not applicable

i If one or more safety contacts are closed, a fault has occurred in the safety path. The proof test has not been passed and must be aborted.

Step 3

1. Re-install the sensor that was removed.
2. Restore the GOOD state by fully exposing the tuning fork.
3. After retracting the fork (plus a response time of approx. 2 s) or after the voltage is restored (plus a response time of approx. 3 s), check the status of the safety contacts.

Terminal	Version				
	II	III	IV	V	VI
4+5	Closed	Not applicable	Closed	Closed	Closed
22+23	Not applicable	Closed	Closed	Closed	Not applicable
26+27	Not applicable	Closed	Closed	Closed	Not applicable

i If one or more safety contacts are open, a fault has occurred in the safety path. The proof test has not been passed and must be aborted.

Version I, test sequence B

Activate simulation by pressing the test button on the Liquiphant or Nivotester.

Step 1

- ▶ Check the current at terminal 2.
 - ↳ The current must be between 2.2 to 3.5 mA.

 If the current is outside the specified tolerance, a fault has occurred in the safety path. The proof test has not been passed and must be aborted.

Step 2

1. Press and hold the test button.
2. Check the current at terminal 2.
 - ↳ The current must be 0 mA.

 If the current is outside the specified tolerance, a fault has occurred in the safety path. The proof test has not been passed and must be aborted.

Step 3

1. Release the test button.
2. Check the current at terminal 2.
 - ↳ After releasing the button (plus a response time of approx. 3 s), the current must be between 2.2 to 3.5 mA.

 If the current is outside the specified tolerance, a fault has occurred in the safety path. The proof test has not been passed and must be aborted.

Version II to VI, test sequence B

Activate simulation by pressing the test button on the Liquiphant or Nivotester.

Step 1

- ▶ Check the status of the safety contacts.

Terminal	Version				
	II	III	IV	V	VI
4+5	Closed	Not applicable	Closed	Closed	Closed
22+23	Not applicable	Closed	Closed	Closed	Not applicable
26+27	Not applicable	Closed	Closed	Closed	Not applicable

 If one or more safety contacts are open, a fault has occurred in the safety path. The proof test has not been passed and must be aborted.

Step 2

1. Press and hold the test button on the Liquiphant or Nivotester.
2. Check the status of the safety contacts.

Terminal	Version				
	II	III	IV	V	VI
4+5	Open	Not applicable	Open	Open	Open
22+23	Not applicable	Open	Open	Open	Not applicable
26+27	Not applicable	Open	Open	Open	Not applicable

 If one or more safety contacts are closed, a fault has occurred in the safety path. The proof test has not been passed and must be aborted.

Step 3

1. Release the test button on the Liquiphant or Nivotester.
2. After releasing the button (plus a response time of approx. 3 s), check the status of the safety contacts.

Terminal	Version				
	II	III	IV	V	VI
4+5	Closed	Not applicable	Closed	Closed	Closed
22+23	Not applicable	Closed	Closed	Closed	Not applicable
26+27	Not applicable	Closed	Closed	Closed	Not applicable

 If one or more safety contacts are open, a fault has occurred in the safety path. The proof test has not been passed and must be aborted.

General, test sequence C

Check the switch point under reference operating conditions.

NOTICE

The test sequence can only be performed if the following conditions are met:

- ▶ Uncoated fork (FTL50, FTL51, FTL50H or FTL51H)
- ▶ Fork material: 316L (order code 020 "Process connection" must end in a 2)
- ▶ Surface Ra < 3.2 µm (126 µin) or Ra < 1.5 µm (59 µin) (order code 030 "Probe length; type" must end in an "A" for FTL50, and FTL51, and in a "C" for FTL50H and FTL51H)

 As proof of functionality is provided indirectly, it cannot be ruled out that a Liquiphant that received a "Good" result in test sequence A "Approach the level or remove" is incorrectly assessed as having "Failed" test sequence C.

Preparation

1. Remove the device and store it at room temperature +24 °C±5 °C (+75 °F±41 °F).
2. Store distilled water at the same temperature.
3. Choose a time when the device and liquid have adapted to the room air

-  Recommendation
- Add a drop of dishwashing detergent, for example, to the distilled or deionized water to reduce the surface of the water curving at walls.
 - The vessel for the test must be of the following dimensions at least: ø50 mm (1.97 in), height 80 mm (3.15 in).
 - The Liquiphant fork must be clearly visible in the area around the switch point (e.g. use a see-through vessel).
 - If using a longer or heavier Liquiphant, fix the sensor in a vertical position and move the vessel.
 - Fit a scale clearly indicating the three switch points on the device or vessel (see the following table).
 - The immersion depth is measured from the lower edge of the fork.
 - Version I: connect the Liquiphant to a suitable power source.
 - Version II to VI: connect the Liquiphant to the Nivotester. For versions V and VI, steps 1 to 3 must be performed separately and consecutively for every Liquiphant, channel and pair of terminals.

Step		Immersion depth	
		Density setting 0.5	Density setting 0.7
1	Immerse "free"	7 to 8 mm (0.28 to 0.31 in)	10 to 11 mm (0.39 to 0.43 in)
2	Immerse "covered"	10.5 to 11.5 mm (0.41 to 0.45 in)	13.5 to 14.5 mm (0.53 to 0.57 in)
3	Retract "free"	6 to 7 mm (0.24 to 0.28 in)	8 to 9 mm (0.31 to 0.35 in)

Version I, test sequence C, MAX detection

Step 1

1. Slowly immerse the tuning fork vertically into the water.
 - ↳ The water surface is within the limits for "Immerse free".
2. Check the current at terminal 2.
 - ↳ The current must be between 2.2 to 3.5 mA.

 If the current is outside the specified tolerance, a fault has occurred in the safety path. The proof test has not been passed and must be aborted.

Step 2

1. Slowly further immerse the tuning fork vertically into the water.
 - ↳ The water surface is within the limits for "Immerse covered".

2. Check the current at terminal 2.
 - ↳ After immersing the fork (plus a response time of approx. 1 s), the current must be between 0.6 to 1.0 mA.

 If the current is outside the specified tolerance, a fault has occurred in the safety path. The proof test has not been passed and must be aborted.

Step 3

1. Slowly retract the tuning fork vertically from the water.
 - ↳ The water surface is within the limits for "Retract free".
2. Check the current at terminal 2.
 - ↳ After retracting the fork (plus a response time of approx. 2 s), the current must be between 2.2 to 3.5 mA.

 If the current is outside the specified tolerance, a fault has occurred in the safety path. The proof test has not been passed and must be aborted.

Version II to VI, test sequence C, MAX detection

Step 1

1. Slowly immerse the tuning fork vertically into the water.
 - ↳ The water surface is within the limits for "Immerse free".
2. Check the status of the safety contacts.

Terminal	Version				
	II	III	IV	V	VI
4+5	Closed	Not applicable	Closed	Closed	Closed
22+23	Not applicable	Closed	Closed	Closed	Not applicable
26+27	Not applicable	Closed	Closed	Closed	Not applicable

 If one or more safety contacts are open, a fault has occurred in the safety path. The proof test has not been passed and must be aborted.

Step 2

1. Slowly further immerse the tuning fork vertically into the water.
 - ↳ The water surface is within the limits for "Immerse covered".
2. After immersing the fork (plus a response time of approx. 1 s), check the status of the safety contacts.

Terminal	Version				
	II	III	IV	V	VI
4+5	Open	Not applicable	Open	Open	Open
22+23	Not applicable	Open	Open	Open	Not applicable
26+27	Not applicable	Open	Open	Open	Not applicable

 If one or more safety contacts are open, a fault has occurred in the safety path. The proof test has not been passed and must be aborted.









Step 3

1. Slowly retract the tuning fork vertically from the water.
 - ↳ The water surface is within the limits for "Retract free".
2. After retracting the fork (plus a response time of approx. 2 s), check the status of the safety contacts.

Terminal	Version				
	II	III	IV	V	VI
4+5	Closed	Not applicable	Closed	Closed	Closed
22+23	Not applicable	Closed	Closed	Closed	Not applicable
26+27	Not applicable	Closed	Closed	Closed	Not applicable

 If one or more safety contacts are open, a fault has occurred in the safety path. The proof test has not been passed and must be aborted.

Life cycle

Requirements for personnel	<p>The personnel for installation, commissioning, diagnostics, repair and maintenance must meet the following requirements:</p> <ul style="list-style-type: none"> ▪ Trained, qualified specialists must have a relevant qualification for this specific function and task ▪ Are authorized by the plant owner/operator ▪ Are familiar with federal/national regulations ▪ Before beginning work, the specialist staff must have read and understood the instructions in the manuals and supplementary documentation as well as in the certificates (depending on the application) ▪ Follow instructions and comply with basic conditions <p>The operating personnel must meet the following requirements:</p> <ul style="list-style-type: none"> ▪ Are instructed and authorized according to the requirements of the task by the facility's owner-operator ▪ Follow the instructions in this manual 																										
Installation	<p>The installation of the device is described in the relevant Operating Instructions (→  16).</p> <p>As the application conditions affect the reliability of the measurement, please pay attention to the notes in the Technical information and Operating Instructions (→  16).</p>																										
Operation	<p>Mandatory settings and information for the safety function (→  22).</p>																										
Maintenance	<p>Maintenance information, .</p> <p> Alternative monitoring measures must be taken to ensure process safety during configuration, proof-testing and maintenance work on the device.</p>																										
Repair	<p> Repair means a one-to-one replacement of components. Repairs on the devices must always be carried out by Endress+Hauser. Safety functions cannot be guaranteed if repairs are carried out by anybody else.</p> <p>Exceptions:</p> <p>Qualified personnel may replace the following components on the condition that original spare parts are used and the relevant Installation Instructions are observed:</p>																										
<table border="1"> <thead> <tr> <th data-bbox="402 1265 710 1310">Component</th> <th data-bbox="710 1265 1013 1310">Installation Instructions</th> <th data-bbox="1013 1265 1441 1310">Checking the device after repair</th> </tr> </thead> <tbody> <tr> <td data-bbox="402 1310 710 1355">Electronic insert</td> <td data-bbox="710 1310 1013 1355">EA01030F/00</td> <td data-bbox="1013 1310 1441 1355" rowspan="2">Proof-testing, see the "Proof-testing" section (→  26) ¹⁾</td> </tr> <tr> <td data-bbox="402 1355 710 1489">Housing cover T13</td> <td data-bbox="710 1355 1013 1489"> <ul style="list-style-type: none"> ▪ EA01049F/00 (electronics) ▪ EA01049F/00 (inspection glass) ▪ EA01050F/00 (connection) </td> </tr> <tr> <td data-bbox="402 1489 710 1534">Housing cover F13</td> <td data-bbox="710 1489 1013 1534">EA01046F/00</td> <td data-bbox="1013 1489 1441 1534"></td> </tr> <tr> <td data-bbox="402 1534 710 1579">Housing cover F15</td> <td data-bbox="710 1534 1013 1579">EA01034F/00</td> <td data-bbox="1013 1534 1441 1579"></td> </tr> <tr> <td data-bbox="402 1579 710 1624">Housing cover F16</td> <td data-bbox="710 1579 1013 1624">EA01035F/00</td> <td data-bbox="1013 1579 1441 1624"></td> </tr> <tr> <td data-bbox="402 1624 710 1668">Housing cover F17</td> <td data-bbox="710 1624 1013 1668">EA01036F/00</td> <td data-bbox="1013 1624 1441 1668"></td> </tr> <tr> <td data-bbox="402 1668 710 1713">Housing cover F27</td> <td data-bbox="710 1668 1013 1713">EA01047F/00</td> <td data-bbox="1013 1668 1441 1713"></td> </tr> <tr> <td data-bbox="402 1713 710 1747">Cover seal F15</td> <td data-bbox="710 1713 1013 1747">KA00620F/00</td> <td data-bbox="1013 1713 1441 1747"></td> </tr> </tbody> </table>		Component	Installation Instructions	Checking the device after repair	Electronic insert	EA01030F/00	Proof-testing, see the "Proof-testing" section (→  26) ¹⁾	Housing cover T13	<ul style="list-style-type: none"> ▪ EA01049F/00 (electronics) ▪ EA01049F/00 (inspection glass) ▪ EA01050F/00 (connection) 	Housing cover F13	EA01046F/00		Housing cover F15	EA01034F/00		Housing cover F16	EA01035F/00		Housing cover F17	EA01036F/00		Housing cover F27	EA01047F/00		Cover seal F15	KA00620F/00	
Component	Installation Instructions	Checking the device after repair																									
Electronic insert	EA01030F/00	Proof-testing, see the "Proof-testing" section (→  26) ¹⁾																									
Housing cover T13	<ul style="list-style-type: none"> ▪ EA01049F/00 (electronics) ▪ EA01049F/00 (inspection glass) ▪ EA01050F/00 (connection) 																										
Housing cover F13	EA01046F/00																										
Housing cover F15	EA01034F/00																										
Housing cover F16	EA01035F/00																										
Housing cover F17	EA01036F/00																										
Housing cover F27	EA01047F/00																										
Cover seal F15	KA00620F/00																										
<p>1) Additional country-specific regulations and tests must be observed.</p>																											
<p>In the event of failure of a SIL-labeled Endress+Hauser device, which has been operated in a protection function, the "Declaration of Contamination and Cleaning" with the corresponding note "Used as SIL device in protective system" must be enclosed when the defective device is returned. Please refer to the "Return" section of the relevant Operating Instructions →  16.</p>																											

Modification



Modifications are changes to devices with SIL capability already delivered or installed.

Modifications to devices with SIL capability are usually performed in the Endress+Hauser manufacturing center.

Modifications to devices with SIL capability onsite at the user's plant are possible following approval by the Endress+Hauser manufacturing center. In this case, the modifications must be performed and documented by an Endress+Hauser service technician.

Modifications to devices with SIL capability by the user are not permitted.

Decommissioning

For detailed information on decommissioning, see the relevant Operating Instructions →  16

Appendix

Structure of the measuring system

System components

The measuring system's devices are displayed in the following diagram (example):

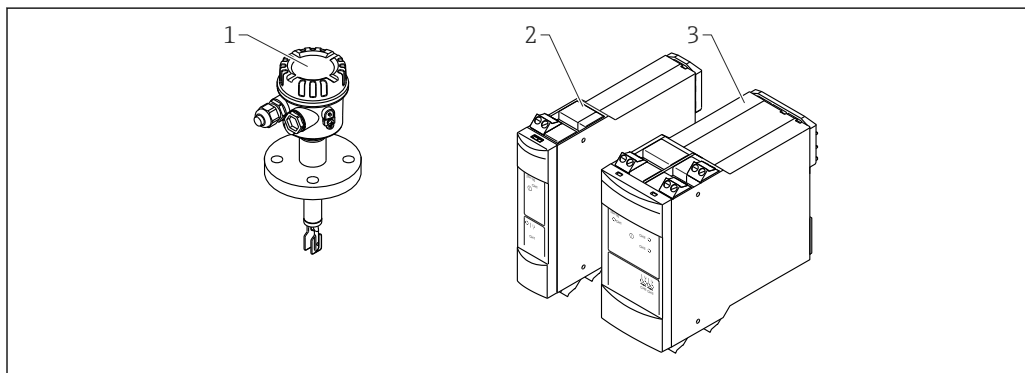

A0025771

- 1 Liquiphant M/S
- 2 1-channel Nivotester FTL325N
- 3 3-channel Nivotester FTL325N

Description of use as a protective system

The sensor's tuning fork vibrates at its intrinsic frequency. The vibration frequency decreases as the density increases. This change in the frequency causes the current signal to change. There is a choice of two operating modes:

- Minimum detection
- Maximum detection

MIN detection

The measuring system is used to protect against a level that is too low (e.g. pump dry running protection, protection against emptying or protection against insufficient filling).

i In normal operation, the tuning fork is covered by liquid and the measuring system reports the "GOOD" state. If the tuning fork is free, the device assumes the safe state and signals the demand mode.

MAX detection

The measuring system is used to protect against a level that is too high (e.g. overflow prevention).

i In normal operation, the tuning fork is not covered by liquid and the measuring system reports the "GOOD" state. If the tuning fork is covered, the device assumes the safe state and signals the demand mode.

The switch point depends on the installation. It is in the area of the tuning fork, see the following diagram.

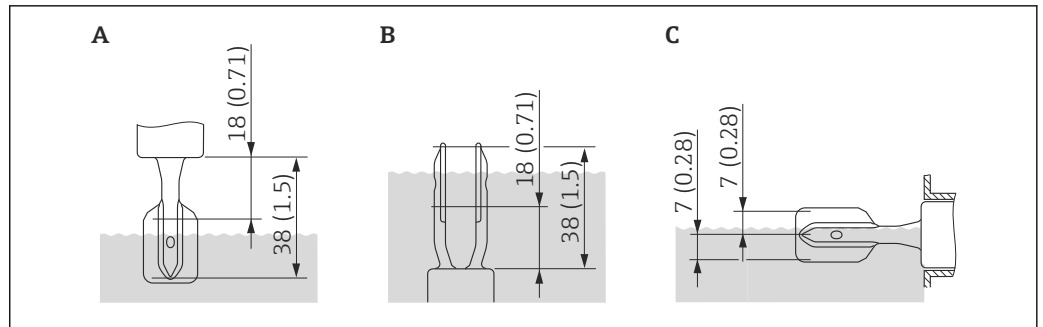

3 Dimensions: mm (in)

- A Installation from above
- B Installation from below
- C Installation from the side

For information about the switch point under reference operating conditions, please refer to the Technical Information, → 16.

i Correct installation is a prerequisite for safe operation of the device.































**Commissioning or
proof test report****Report for version I**

System-specific data				
Company				
Measuring point/TAG no.				
Facility				
Device type/Order code				
Serial no. Liquiphant				
Name				
Date				
Signature				
Operating mode, density range and version (please tick appropriate box)				
Mode of operation	MIN safety			<input type="checkbox"/>
	MAX safety			<input type="checkbox"/>
Density switch	Setting >0.7			<input type="checkbox"/>
	Setting >0.5			<input type="checkbox"/>
Version	I	One Liquiphant, no Nivotester	Electronic insert FEL56	<input type="checkbox"/>
			Electronic insert FEL58	<input type="checkbox"/>
Commissioning or proof test report				
Test sequence	A	Approach the level		<input type="checkbox"/>
		Remove and immerse in a medium of similar density and viscosity		<input type="checkbox"/>
	B	Perform simulation on the Liquiphant by pressing the test button ¹⁾		<input type="checkbox"/>
	C	Check the switch point under reference operating conditions. ²⁾		<input type="checkbox"/>
Current at terminal 2				
Test step	Terminal	Set point FEL56	Set point FEL58	Actual value
Step 1 (GOOD state)		0.6 to 1.0 mA	2.2 to 3.5 mA	
Step 2 (demand mode)		2.2 to 2.8 mA	A, C: 0.6 to 1.0 mA B: 0 mA	
Step 3 (GOOD state)		0.6 to 1.0 mA	2.2 to 3.5 mA	
Conclusion	Passed <input type="checkbox"/>			Failed <input type="checkbox"/>

1) Only for Liquiphant with electronic insert FEL58.

2) For restrictions and immersion depths, see → 35

Report for versions II to VI

System-specific data							
Company							
Measuring point/TAG no.							
Facility							
Device type/Order code							
Serial no. Liquiphant(en)							
Serial no. Nivotester							
Name							
Date							
Signature							
Operating mode, density range and version (please tick appropriate box)							
Mode of operation	MIN safety						<input type="checkbox"/>
	MAX safety						<input type="checkbox"/>
Density switch	Setting >0.7						<input type="checkbox"/>
	Setting >0.5						<input type="checkbox"/>
Version	II	One Liquiphant on one channel (1001)					<input type="checkbox"/>
	III	One Liquiphant (1001), output relay CH2 and CH3 switched in series (1002)					<input type="checkbox"/>
	IV	Two Liquiphant devices (1002), output relay CH1, CH2 and CH3 switched in series (1003)					<input type="checkbox"/>
	V	Three Liquiphant devices, evaluation e.g., by PLC (2003)					<input type="checkbox"/>
	VI	Three Liquiphant devices, 1 x SIL, 2 x level control (Δ s)					<input type="checkbox"/>
Commissioning or proof test report							
Test sequence	A	Approach the level					<input type="checkbox"/>
		Remove and immerse in a medium of similar density and viscosity					<input type="checkbox"/>
	B	Perform simulation on Liquiphant by pressing test button ¹⁾					<input type="checkbox"/>
		Perform simulation on Nivotester by pressing test button					<input type="checkbox"/>
C	Check the switch point under reference operating conditions. ²⁾					<input type="checkbox"/>	
		Version					
Test step	Terminal	II	III	IV	V	VI	Actual value
Step 1	4+5		³⁾				
(GOOD state)	22+23	³⁾				⁴⁾	
Switch is closed	26+27	³⁾				⁴⁾	
Step 2	4+5		³⁾				
(demand mode)	22+23	³⁾				⁴⁾	
Switch is open	26+27	³⁾				⁴⁾	
Step 3	4+5		³⁾				
(GOOD state)	22+23	³⁾				⁴⁾	
Switch is closed	26+27	³⁾				⁴⁾	

System-specific data

Conclusion	Passed <input type="checkbox"/>	Failed <input type="checkbox"/>
-------------------	---------------------------------	---------------------------------

- 1) Only for Liquiphant with electronic insert FEL58 + Nivotester FLT325N.
- 2) For restrictions and immersion depths, see →  35
- 3) Not applicable as channel is not used.
- 4) Not relevant for SIL, is used for level control (Δ s).

Further information

General information on functional safety (SIL) is available at:

www.de.endress.com/SIL (Germany) or www.endress.com/SIL (English) and in the Competence Brochure CP01008Z/11 "Functional Safety in the Process Industry- Risk Reduction with Safety Instrumented Systems".

Version history

Version	Changes	Valid for hardware version
SD00161F/00/EN/02.10 (MAX) SD00170F/00/EN/13.13 (MIN)	First version	01.00
SD01522F/00/EN/01.15	<ul style="list-style-type: none"> ▪ MIN (SD00170F) and MAX (SD00161F) merged ▪ Nivotester Update to C 61508-2011 	02.00
SD01522F/00/EN/02.16	New declaration of conformity	02.00



71386531

www.addresses.endress.com